



TECHNICAL UNIVERSITY OF LIBEREC  
Faculty of Textile Engineering ■

# **A Study On The comfort and Thermo- Physiological Properties of Car seats**

Ing. Funda Büyük Mazari

**SUMMARY OF THE THESIS**

**Title of the thesis:** A Study On The comfort and Thermo-Physiological Properties of Car Seats

**Author:** Ing. Funda Büyük Mazari

**Field of study:** Textilní technika a materiálové inženýrství

**Mode of study:** Full time

**Department:** Department of Clothing Technology

**Supervisor:** Doc. Ing. Antonín Havelka, CSc.

**Committee for the defense of the dissertation:**

Chairman: prof. Dr. Ing. Zdeněk Kůs	FT TUL, Department of Clothing Technology
Vice-chairman: prof. Ing. Luboš Hes, DrSc., Dr.h.c.	FT TUL, Department of Textile Evaluation
prof. Ing. Karel Adámek, CSc. (opponent)	
doc. Ing. Vladimír Bajzík, Ph.D.	FT TUL, Department of Textile Evaluation
doc. Ing. David Cirkl, Ph.D. (opponent)	FS TUL, Department of Applied Mechanics
doc. Ing. Lukáš Čapek, Ph.D.	FT TUL, Department of Technology and Structures
doc. Ing. Josef Dvořák, CSc.	VÚTS, a. s., Liberec
doc. RNDr. Miroslav Šulc, Ph.D.	FP TUL, Department of Physics
Ing. Bc. Viera Glombíková, Ph.D.	FT TUL, Department of Clothing Technology

This dissertation is available at the Dean's office FT TUL.

Liberec 2017

## Abstract

In this research the comfort and the thermo-physiological properties of the car seat's cover is examined. Car seats are made up of multiple layers of textile material with Poly-Urethane foam as cushion material. The research is organized to make the car seat more breathable and keeps the microclimate between the driver and the seat as dry as possible.

Firstly the factors affecting the breathability of car seat are examined. For this the car seat's cover material are tested for moisture and air permeability and compared with the properties of individual layer of the car seat cover material. This analysis gives us a real idea of which factors negatively affects the breathability of the car seat. The focus of this part of research was to identify the issues within the car seat material and not factors like external cooling or clothing of driver. It was observed that the PU foam and lamination significantly reduces the permeability of the car seats. Whereas the 3D spacer fabric shows the best top layer properties as compared to classical woven, knitted or leather car seat covers.

Secondly with the knowledge of the factors affecting the breathability of the car seats, different techniques are used to improve the breathability of the car seat. In this research the breathability of the car seat is improved by using PU foam with molded perforation & laser cutting, Super Absorbents to absorb excess moisture and stitching car seat layers without lamination. Results show that all techniques significantly improve the breathability of the car seat without sacrificing the aesthetic properties. The research work is initial work on replacing the car seat with perforated PU-foams with Super Absorbents.

Thirdly doing any improvement in design of the car seat brings doubt for the durability or life time of the car seat. The most improvement factors which influences the life time of the car seat is the compression properties of the layer and PU foam with time. In this research firstly the pressure distribution of driver on the car seat are examined. Experiment is performed with 50 randomly chosen people; who have different weight and height. Each person sits in three different angles ( $90^\circ$ ,  $100^\circ$  and  $110^\circ$ ) of sitting position. These results is beneficial for us to test the car seat under repeated loading. A special testing was arranged in which a repeated load was applied on the car seat's cover material to 10000 times, which provides the actual life time performance of the classical and newly designed layers for the car seat.

Fourthly the experimental techniques for the measurement for car seats need a lot of improvement. The complete car seat testing is almost impossible to identify the performance of car seat comfort, and usually each layer is tested separately. In this research we designed thin sheet of sensor which can be placed above the car seat during driving to obtain actual humidity and temperature level. Thermal cameras are used to obtain the thermal field of the car seat after usage. A unique portable device is made to observe the heat flux of the car seat. Then the standard CUP method is modified to measure the water vapour permeability under loading. All this novel techniques gives us better information about the comfort of the car seats.

Lastly A theoretical model is made for predicting the airflow through the Car seat material considering the air flow and moisture permeability are related to each other in the case of car seats. The model is initial approach to design layer and see the performance of the car seat including loading on the car seat. The research is beneficial for the industry as well as the scientific researchers.

**Keywords:** car seat, comfort, PU-foam, 3D spacer fabric, Super absorbents

## Anotace

Tento výzkum se zaměřuje na hodnocení termo-fyziologických vlastností potahů autosedaček. Potahy autosedaček jsou tvořeny z několika vrstev textilních materiálů a z polyuretanové pěny jako čalounického materiálu. Koncepce výzkumu se zaměřuje na to, aby byla autosedačka prodyšnější, a udržovala mikroklima mezi řidičem a sedadlem bez přítomnosti vlhkosti.

Napřed byly zkoumány faktory ovlivňující prodyšnost autosedaček. Krycí potah autosedaček je testován na vlhkost a prodyšnost vzduchu a výsledky jsou pak porovnávány s vlastnostmi jednotlivých vrstev potahu autosedaček. Tato analýza nám dává reálnou představu o tom, které faktory negativně ovlivňuje prodyšnost autosedačky. Těžištěm této části výzkumu bylo identifikovat problémy v rámci jednotlivých vrstev potahů a nikoli vnější faktory jako jsou externí chlazení nebo oděv řidiče. Bylo pozorováno, že potah s PU pěnou a laminováním výrazně snižuje propustnosti (vlhkosti a vzduchu) sedaček automobilů, zatímco potah s 3D distanční textilií vykazuje nejlepší užité vlastnosti v porovnání s klasickými tkanými, pletenými nebo koženými potahy.

V druhé části, se znalostí faktorů, které mají vliv na prodyšnost autosedaček, byly vyzkoušeny různé postupy ke zlepšení parametrů prodyšnosti autosedaček. V tomto výzkumu je prodyšnost autosedačky zlepšena pomocí PU pěny s použitím perforace a řezání laserem, použitím super absorbentů, které absorbují přebytečnou vlhkost, a vrstvy potahu autosedačky bez použití laminace. Výsledky ukazují, že všechny tři použité techniky výrazně zlepšují prodyšnost autosedačky, aniž by tomu byly obětovány estetické vlastnosti autosedačky. Výzkum je počáteční prací při nahrazování potahů autosedaček potahem s perforovanou PU pěnou se super absorbenty.

Následně, provádění změn v konstrukci autosedačky vyvolalo pochybnosti o trvanlivosti či životnosti autosedačky. Nejvíce zlepšujícím faktorem, který ovlivňuje životnost autosedačky, jsou kompresní vlastnosti při stlačení vrstvy PU pěny v průběhu času. Nejprve se zkoumá rozložení tlaku řidiče na sedadle automobilu. Experiment se provádí za použití 50-ti náhodně vybraných lidí různé výšky a váhy. Každý člověk sedí ve třech různých úhlech (90°, 100° a 110°). Výsledky z tohoto experimentu nám umožňují testovat autosedačku při opakovaném namáhání. Byla provedena speciální zkouška, při které byl potah autosedačky opakovaně (10000krát) zatížen pro simulaci odolnosti potahu proti namáhání, což umožňovalo simulovaně porovnat trvanlivost klasického potahu a nově navrženého potahu autosedačky při jejich reálném použití.

Dále bylo nezbytné experimentální techniky pro měření autosedaček ještě upravit a vylepšit. Kompletní testování autosedaček je náročné a je téměř nemožné určit výkonnost a komfort autosedačky, obvykle se tak testuje každá vrstva samostatně. V tomto výzkumu bylo navrženo řešení tenkého potahu se senzory, který může být umístěn na povrchu autosedačky pro zjišťování údajů o teplotě a vlhkosti během simulace jízdy. Termo kamery pak slouží pro záznam a vizualizaci tepelného pole autosedaček po sezení. Byl vyroben unikátní přenosný přístroj pro sledování tepelného toku z autosedačky. Misková metoda byla upravena tak, aby umožňovala měření propustnosti vodní páry pod zatížením. Všechny tyto nové techniky nám poskytují lepší informace o komfortu autosedaček.

Nakonec byl vytvořen teoretický model pro predikci proudění vzduchu skrze materiál autosedačky s ohledem na proudění vzduchu a propustnost par, které spolu u autosedaček

vzájemně souvisí. Tento model je počátečním přístupem k návrhu vrstev potahu a pro sledování plnění funkce a komfortu autosedaček při jejich zatížení. Tento výzkum je prospěšný jak pro průmysl, tak pro vědecké pracovníky.

**Klíčová slova:** autosedačka, komfort, PU pěna, 3D tkanina, distanční tkanina, super absorbent

## Contents

1	Introduction.....	7
2	Purpose and aims of the thesis .....	9
2.1	To identify the factors that affect the breathability of car seats .....	9
2.2	To improve the overall comfort properties of car seat .....	9
2.3	Testing the compressibility properties of newly design layers .....	10
2.4	Novel techniques for experimental measurement .....	10
2.5	Theoretical Model: Analyzing theoretically the air flow through car seat foam material .....	10
3	Overview of the current state of the problem.....	10
3.1	Material and design.....	10
3.2	Experimental techniques .....	10
3.3	Compression properties and lifetime of car seat cover .....	11
4	Used methods, study material .....	12
5	Summary of the results achieved .....	14
5.1	Factors affecting the breathability of car seat .....	14
1.2	Effect of interlining thickness .....	16
1.3	Effect of different car seat's cover materials .....	17
5.2	To improve the overall comfort properties of car seat .....	19
5.2.1	Perforation in foam using Laser technology .....	21
5.3	Super absorbent fibres (SAF).....	22
5.3.1	Absorption desorption isotherm.....	23
5.3.2	Climate chamber measurement .....	24
5.4	Compressibility properties of the novel designs .....	25
5.5	Novel techniques to measure moisture permeability .....	27
5.5.1	Measurement of moisture permeability under load .....	27
5.6	Theoretical Model: Analysing theoretically the air flow through car seat foam material .....	29
6	Evaluation of results and new findings .....	32
7	References.....	35
8	List of papers published by the author .....	36
8.1	Publications in journals.....	36
8.2	Contribution in conference proceeding .....	37
8.3	Quotation.....	38
	Brief description of the current expertise, research and scientific activities.....	40

# 1 Introduction

Comfort is the basic and universal necessity of human being. Though, it is very complicated and challenging to define. Slater [1] defined comfort as pleasant state of psychological, physiological, neurophysiological and physical harmony between environment and human being. Every middle-size vehicle uses between 12 and 14 Kg of textile products, without including tire cords for pneumatic and fibers which are used in composite materials. The 65% of this quantity is used, approximately, in the interior (40 to 45 m<sup>2</sup> of textile material per car) with a weight between 350 and 450 g/ m<sup>2</sup> for the seats upholstery [2,3,4].

Textile advances in the automotive industry have been spearheaded by advances in science and technology of fibres and fabric/web forming technologies. These advances have led to the development of textiles and textile-based components for a broad variety of automotive applications which are capable of meeting the industry's tough specifications regarding high performance during use [5].

Car production development of components, parts, pieces and materials is orientated by the following criteria:

- Comfort
- Functionality
- Safety
- Economy
- Ecology

Car seat is perhaps, the most important part of the interior, it is the first element that the customer appreciates when he/she opens the door to look inside and it is the main interface between person and machine.

Therefore, the comfort is the first criterion that values the customer, specifically psychological comfort - makes reference to the aesthetic aspects - and physiological comfort captured by the view and touch. During the sitting the thermal comfort is evaluated by the "cold-hot" sensation. Functionality and material safety criteria are captured during use of the vehicle, by means of wear, seat ventilation, the internal environment, ease of care, etc[3].

### **1.1.1 THERMOPHYSIOLOGICAL COMFORT OF CAR SEATS**

Today, comfort has become a major quality criterion of cars. Comfort in a car is a complex phenomenon and comprises such different aspects. One of the most important factor influencing passenger convenience is thermal comfort. Therefore, car manufacturers are paying a lot of attention to this aspect, as can be seen by an increased application of air conditioning in the car [6]

A particularly important aspect of vehicle comfort is the seats. Seats do not only have to have an attractive design or meet specific design criteria for safety reasons, they must also have optimum comfort properties. Scientific findings show that the performance of a driver over long distances significantly decreases if the car seats do not support posture and heat balance as required. This leads to exhaustion and loss of concentration, which, in extreme cases, could result in serious accidents [7,8]

#### **1.1.2 Parameters of seating comfort**

From the physiological point of view, seat comfort comprises the following four parameters:

[6]:

- i. The initial heat flow following the first contact with the seat. In other words; the sensation of warmth or cold in the first few minutes or even seconds after entering the car.
- ii. The dry heat flow on long journeys, i.e. the amount of body heat transferred by the seat.
- iii. The ability known as “breathability” to transfer any sweating away from the body. In so-called “normal sitting situations” there is no perceptible perspiration, but, nevertheless, the human body constantly releases moisture (so-called ‘insensible perspiration’), which has to be taken away from the body
- iv. In the event of heavy perspiration (a car in the summer heat, stressful traffic situations) the ability to absorb perspiration without the seat feeling damp.

25% of human body is in contact with car seat and the car seat acts as an extra layer of the clothing thus the effecting parameter of the clothing comfort is the same for car seat thermal comfort as well.

The passenger is already sensing his first thermal impression of a car seat while entering the vehicle. This initial perception of warmth after sitting depends on the thermal absorptivity of the car seat. It is effected by is its heat capacity of the car seat material. Heat capacity is amount of



heat required to raise its temperature one degree. Heat capacity varies with the mass of the cushion and the type of material. Thermal conductivity is also another parameter of the thermal absorbency and the thermal absorbtivity should be as low as possible; otherwise a car seat feels cold in the winter time or hot during summer [6,9]

The moisture sensation of the passenger is very important for perceived overall seat comfort. In order to achieve a dry microclimate, the ability, known as ‘breathability’, of the seat to transport any perspiration formed away from the body is crucial. Not only under warm summer conditions is good water vapour transport necessary, but even when there is no perceptible perspiration. The human body constantly releases moisture, the so-called ‘insensible perspiration’. As the skin is not totally water vapour tight, our body loses at least 30 grams of moisture per hour and car seat has to manage perspiration.[6].

Moisture accumulation results in discomfort and, in some cases, an increased risk of soft tissue damage.

## **2 Purpose and aims of the thesis**

The objectives of the study are

- To identify the factors that affect the breathability of car seats
- Analyzing the pressure distribution on car seat
- To improve the overall comfort properties of car seat
- Testing the compressibility properties of newly design layers
- Novel techniques for experimental measurement
- Theoretical Model for air flow through car seat foam material

### **2.1 To identify the factors that affect the breathability of car seats**

- Testing overall air and moisture permeability of materials used in car seats.
- Analyzing the effect of different layers and lamination on the breathability of car seats.
- Identifying the problem issue for breathability of car seats.

### **2.2 To improve the overall comfort properties of car seat**

- Effect of perforation on the breathability of car seat.

- Use of Super Absorbent fiber to keeping microclimate dry.
- Effect of different interlinings of car seat on breathability of car seat

### **2.3 Testing the compressibility properties of newly design layers**

- Testing the newly designed layer under repeated load for life time of car seat cover
- Comparing the different car seat cover materials under repeated load

### **2.4 Novel techniques for experimental measurement**

- Designing instrument for moisture permeability under load.
- Thermal camera, sensor sheet and portable device to measure comfort performance of car seat

### **2.5 Theoretical Model: Analyzing theoretically the air flow through car seat foam material**

- Theoretically analysing the flow of air through the PU- foam of car seat

## **3 Overview of the current state of the problem**

### **3.1 Material and design**

There are many kinds and design available for the car seat cover, it is necessary to analyse the effectiveness of these material and placement by experiment. New material like 3D spacer fabric, superabsorbent, reticulated foams and nonwoven linings needs further experimental analysis related to their performance and effectiveness, and the Evaluation of the car seat thermal comfort should be done with all car seat structure together not only the top layer of the car seat.

**Therefore, it's necessary to examine the role of different material for the comfort of car seat.**

### **3.2 Experimental techniques**

The experimental verification by most of the researchers is done by measuring the top single layer of the car seat's cover using the skin model. The complete combination of car seat cover with the cushion is not studies mostly by the producers as the experimental measurement of thick car seat cover is impossible to measure using classical machines and effect of non-porous foam and the lamination is mostly neglected. It is necessary to use different experimental technique to compare the results and also find suitable technique to measure the breathability of the car seat

cover with cushion and also under load to observe the real time performance of the complete car seat. The measurement by subjective and objective techniques is also necessary to obtain valuable results. The porosity of the material is important parameter effecting the thermal properties, also the porosity of the compressible materials changes with loading on the top. So that material can show different breathability under loading. **Therefore it is important to develop measurement technique to measure car seat material under different load.**

On the other hand, experimental techniques should be developed to measure the comfort of the whole car seat. Commercial measurement techniques gives us the opportunity to measure the thermal properties of the car seat layer but there are also other parameter affecting thermal comfort of the car seats other than materials, such as heating and the ventilation of the car seat. With new experimental techniques it is possible to evaluate the car seat comfort with other effecting parameter that gives us more realistic values of car seat comfort and comparison of different car seats is possible

### **3.3 Compression properties and lifetime of car seat cover**

Any modification to car seat cover especially to the PU-foam part may cause a dramatic decrease in its thickness in longer run. The change of thickness changes the porosity and comfort performance of the car seat. Due to this reason the producers are hesitant to make any changes especially to the PU-foam to avoid changes in thickness over time. It is necessary to observe the change on thickness and properties of car seat materials under repeated loading to understand durability.

**Therefore, classical and modified PU-foams and the other materials used for interlining of car seat must undergo some test of repeated loading to observe its thickness change over time.**

## 4 Used methods, study material

The experimental part of the research included different combination of car seats cover and the lining material including poly-urethane foam. The classical car seat is made of multiple layers as shown in figure 1.

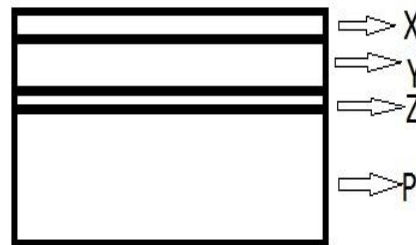


Figure 1 Layers of car seat

Where

X is top fabric layer which touches the person/driver

Y is second layer made of thin poly-urethane foam

Z is thin porous polyester mesh

P is thick (6-10cm) PU-foam

The top layer of the fabric are ordered from Company Johnson Control (CZE)

Classical thick PU-foams are obtained for the car seat from the company GRAMMER (Germany). It is one of the biggest car seat producers in the world. The details of the foams are as shown in table 1.

Table 1 Types of cushion foams

Foam Type	Density [Kg/m <sup>3</sup> ]	Thickness [cm]
TDI	40.24	6 and 8.5
	46.16	6 and 8.5
MDI	54.65	6 and 8.5
	60.6	6 and 8.5

The Figure 2 shows the real picture of the perforated foams



Figure 2 real picture of the perforated foams

The properties of self-perforated foam are shown in table 2.

**Table 2 Properties for perforated PU foam used for the experiment**

	Foam thickness	Number of holes	Hole diameter	Total area of foam sample	Area of holes	Area of solid foam
	mm		mm	mm <sup>2</sup>	mm <sup>2</sup>	mm <sup>2</sup>
A	60	0	0	16505	0	16505
A1	60	7	10	16505	550	15955
A2	60	7	15	16505	1236	15268
A3	60	7	20	16505	2198	14307
B	85	0	0	16505	0	16505
B1	85	7	10	16505	550	15955
B2	85	7	15	16505	1236	15268
B3	85	7	20	16505	2198	14307

Super absorbent materials were specially obtained from the company TECHABSORBENTS.

The properties of the obtained Superabsorbent are shown in table 3

**Table 3 SAF Properties**

	Composition	Structure	Areal weight (g/m <sup>2</sup> )	Thickness (mm)
A	Polyester staple fiber	Needle felt, non-woven	570	5.4
B	Fluff pulp	Bi component fiber	130	1.6
C	Polyester staple fiber	Super absorbent yarn netting, laminated with PES weave	115	1

Climatic conditions in Lab

- temperature of air: 22 °C
- relative humidity of air: 62 %

Following instruments are used to perform this research,

- 1- Air permeability tester (FX-3300) for air permeability testing
- 2- SDL MO21S Air Permeability Tester
- 3- C-Therm TCi Thermal Conductivity Analyzer
- 4- Alambeta and Permatest for thermal resistance and moisture resistance of material
- 5- Atlas sweating guarded hot plate for water vapour resistance measurement of thick samples like PU foam(ISO 11092)

- 6- X-ray tomography to analyse the internal structure of samples to see the pore structure and air gaps.
- 7- Upright Cup method to analyse the loss of water vapour loss from thick layers of car seat. (ASTM E 96-66)
- 8- Novel techniques to measure the moisture permeability under load.
- 9- Dynamic compression tester to analyse the performance of material under long term use.
- 10- X-sensor pressure sensing sheet to determine the average load on the car seat.
- 11- Thermal camera (FLIR) for direct measurement of thermal field on car seat
- 12- Sensor sheet to obtain direct measurement of temperature and humidity.

## 5 Summary of the results achieved

### 5.1 Factors affecting the breathability of car seat

Car seats are made of multiple layers and each layer has unique importance for the comfort, and durability of car seat. The top layer is mostly made permeable to air and moisture but the bottom and middle layer made up of PU-foam are known for being impermeable. But PU-foam is easy to use, cheaper to produce, durable and long life so they are an essential part of the car seat. For this research all material types mentioned in the Experimental Part are tested for air and moisture permeability using device FX3300 and Atlas SGHP respectively. The results are represented as minimum and maximum of each group of material which gives us better idea where the actual problem with the breathability of the car seat is.

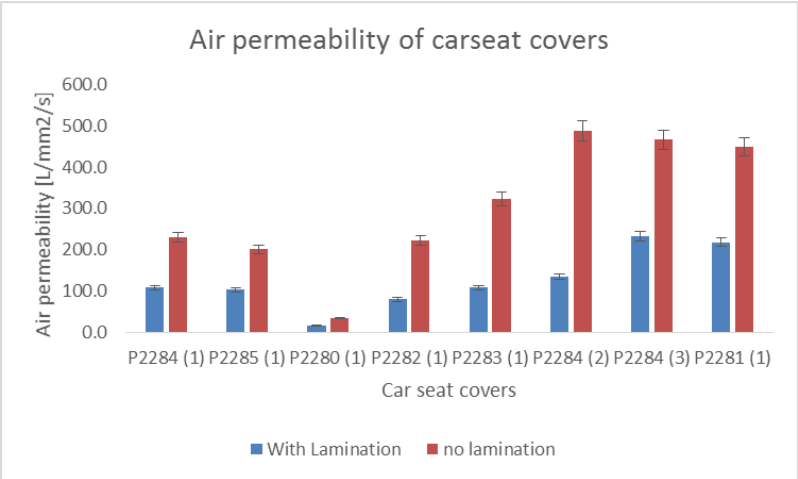
Different material shown in experimental part under each layer (X, Y and Z from figure 1) of car seat are tested for the air permeability and results are shown in table 4.

**Table 4 Air permeability of each layer of car seat**

Material	Air permeability (Min – Max) [L/m <sup>2</sup> /s]
Different top layers-X	2000-5000
PU-thin foam -Y	700-920
Knit mesh-Z	9000-9400
PU-foam -P	15-25

This table 4 clearly shows the PU foam dramatically decreases the air permeability, even though the top layers are highly breathable but complete sandwich structure will not allow the flow of air.

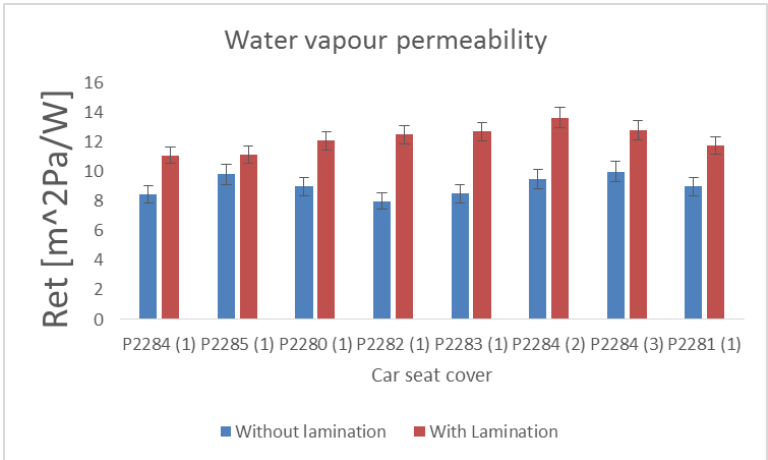
To see the effect of lamination the car seat cover material were tested for air permeability. All the material are tested with (flame lamination) and without lamination and results are shown in figure 3 and 4.



**Figure 3 Effect of lamination on air permeability**

The results clearly show that the lamination significantly affect the air permeability of the car seat cover. The lamination is mostly a polymeric material which melts to stick the two layers and eventually closes the pores of the textile layer.

The set of sample were also tested for the water vapour resistance with the machine Atlas SGHP. Each experiment is repeated 5 times for mean value.



**Figure 4 Effect of lamination on water vapour resistance**

The similar trend can be seen that the laminated layers significantly affect the moisture permeability of the car seat’s cover material.

### 1.2 Effect of interlining thickness

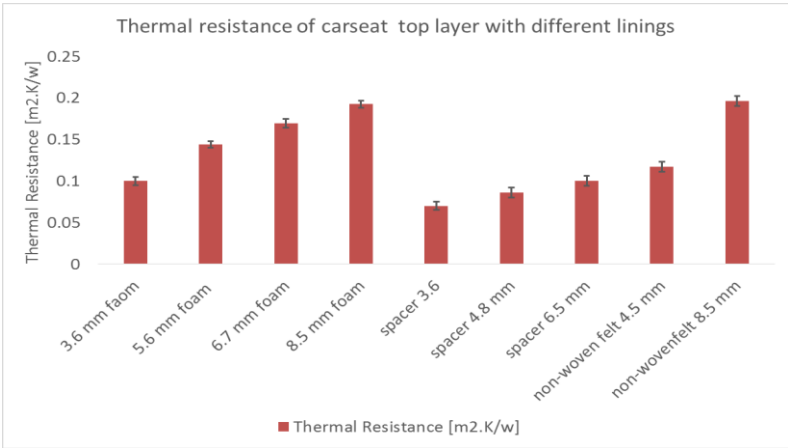
One selected top layer fabric is tested with different interlining materials to see the effect of interlining thickness and material on the breathability of the car seat cover.

Table 5 shows the different kinds of interlining materials used for this experiment.

**Table 5 Car seat cover interlining samples**

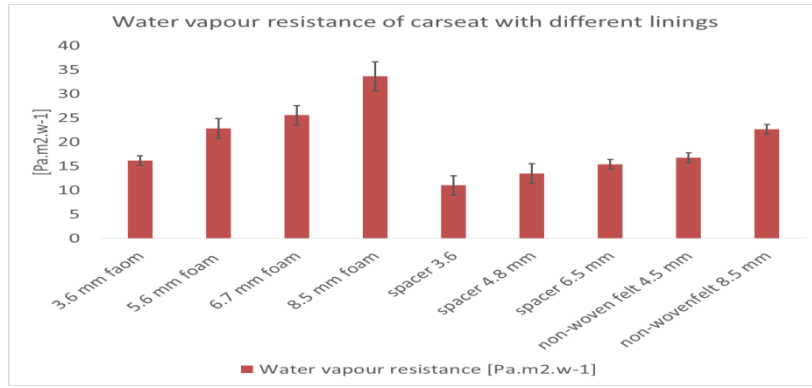
Samples	Car seat top layer(2284-1)+ Interlining
1	3.6 mm foam
2	5.6 mm foam
3	6.7 mm foam
4	8.5 mm foam
5	3D spacer 3.6
6	3D spacer 4.8 mm
7	3D spacer 6.5 mm
8	Non-woven felt 4.5 mm
9	Non-woven felt 8.5 mm

Figure 5-7 shows the thermal resistance, water vapor resistance and air permeability of the car seat covers respectively. It is easily seen that 3D spacer fabric shows minimum thermal resistance, water vapour resistance and the highest air permeability; both these factors plays a significant role for the comfort of the car seat

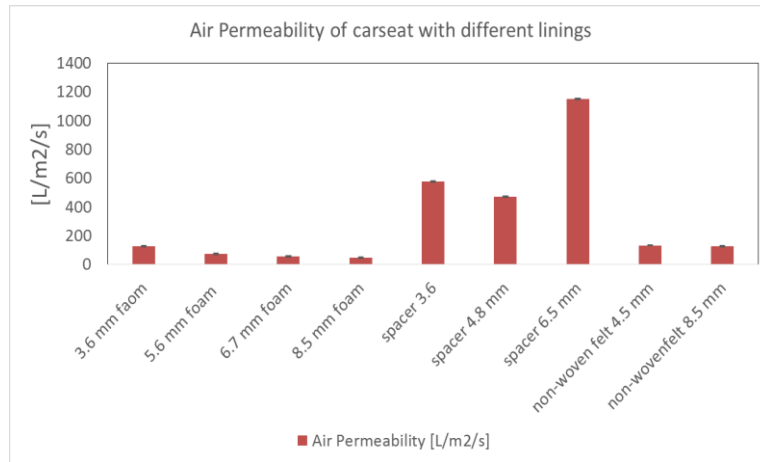


**Figure 5 Thermal resistance of top layer with interlinings**





**Figure 6 WVR of top layer with interlinings**



**Figure 7 Air permeability of top layer with interlinings**

The results shown in the fig. 6 clearly shows that the 3D spacer fabrics are highly breathable than the layers.

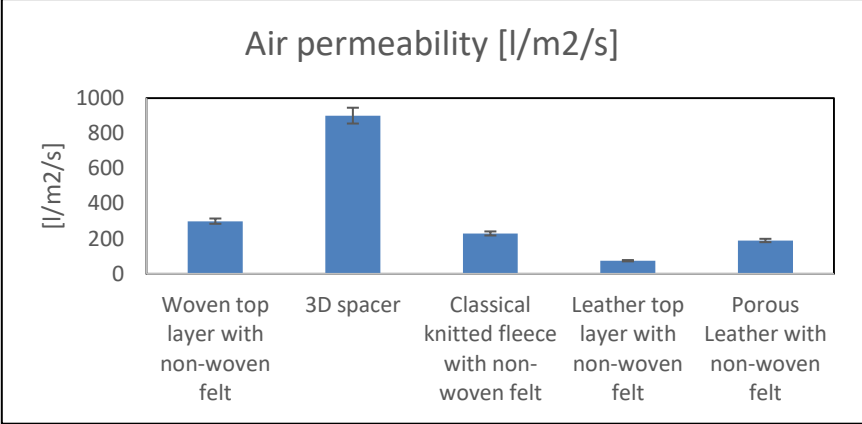
### 1.3 Effect of different car seat's cover materials

A huge variety of car seat's top layers exist in the market and choice is mainly dependent on aesthetic, life time and comfort. Five common car seat covers from car seat cover producer company GRAMMER are tested to compare the breathability of the material. Table 6 shows the properties of the car seat covers

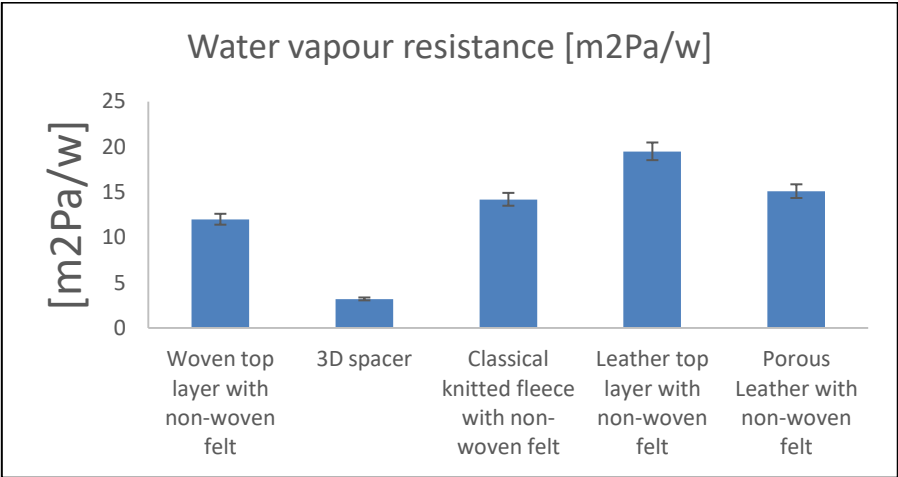
**Table 6 Comparison of different top layers**

Type of layer	Thickness [mm]
Woven top layer with non-woven felt	5
3D spacer	5
Classical knitted fleece with non-woven felt	5
Leather top layer with non-woven felt	5
Porous Leather with non-woven felt	5

Considering the comfort part we need the top layer to be highly breathable. The moisture and air permeability is shown in figure 8 and 9.



**Figure 8 permeability of top layers**



**Figure 9 Water vapour resistance of top layer**

It is visible that the air permeability is higher for the 3D spacer fabrics which is mainly due to open structure of the 3D spacer fabric and also the lowest water vapour resistance that shows that the future of car seats will be 3D spacer fabric. Leather porous textile layer shows better properties as compared to classical leather car seat cover.

It is also important to understand that car seat top layers are usually joined to thin PU-foam (usually 3-12 mm) to make the final long lasting car seat cover. These backing material is also negatively affecting the breathability of car seat as it is mostly made from PU-foam or non-woven felt.

There have been interesting developments taking place in the production of 3D fabrics using all forms of manufacturing technologies like weaving, knitting, braiding and nonwoven processes. The 3D textile structures have great potential as automotive components in both load-bearing and non-load bearing applications. For example, spacer fabrics can be used as substitutes for polyurethane (PU) foam in car seats and thereby solve breathability and the recycling problems with PU foam.

Lastly it is clearly observed that the PU-foam are almost impermeable to air. The top layer and the PU-foam are also examined under the X-ray tomography machine to see the internal structure of the material.

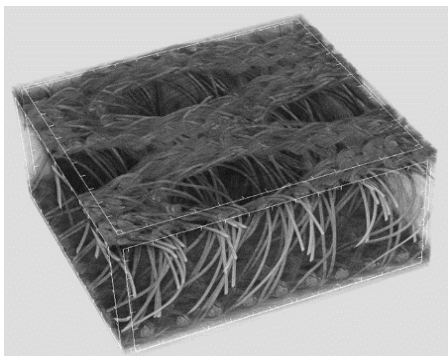


Figure 10 X-ray tomography image of 3D spacer Fabric

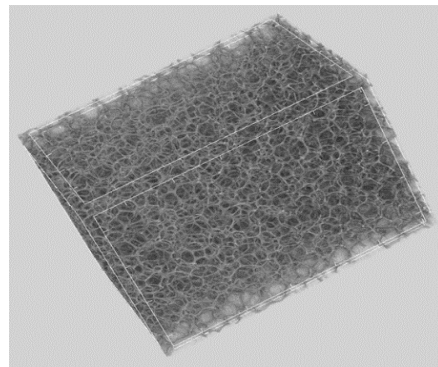


Figure 11 X-ray tomography image of PU foam

The figure 10-11 clearly shows by X-RAY tomography that the PU-foam has closed pore structure which makes the material almost impermeable to the flow of air and moisture, where as in the case of the 3D space knitted fabric there is high porosity and the air can pass from one side to another side of the material which makes it highly permeable.

## 5.2 To improve the overall comfort properties of car seat

The overall car seat can be improved by making modification to the car seat material or using the forced ventilation/suction or cooling from inside seat. Our focus of research is mainly to improve the car seat breathability with changes to the material and accessories like ventilation or cooling can be on the choice of the producers. In this research we did 3 major improvements to the car seat cover for better breathability.

- Effect of perforation on breathability of PU-Foams
- Effect of different top layer of car seat on breathability of car seat
- Effect of Super absorbent fibres (SAF)

### 5.2.1 Effect of perforation on breathability of PU-Foams

All the PU foams showed in table 2 are tested for the moisture permeability by upright cup method (ASTM E 96-66) for water vapour permeability; the test is performed for 3 hours and measurement are obtained after every 1 hours.

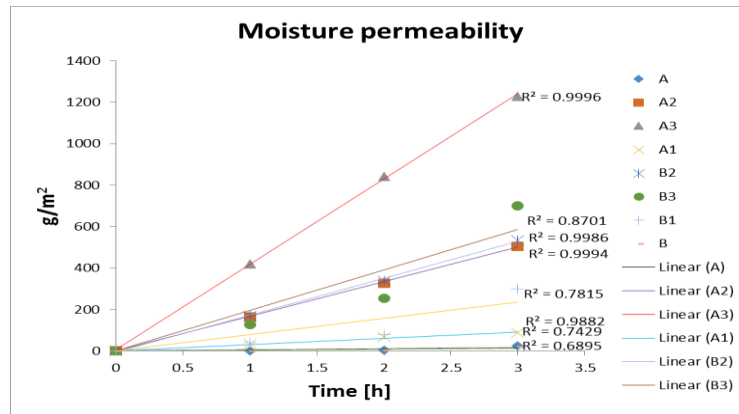


Figure 12 Moisture permeability through PU-foam

It is observed from figure 12 that the non-perforated foams A and B are almost impermeable to moisture and bigger size of the porosity is causing higher breathability of the foam, the foam A3 and B3 have the maximum air area (area of the holes) in the sample and shows a significant increase in the moisture permeability of the sample. A3 sample shows more permeability than the B3 which is due to the thickness difference of the sample and moisture permeability is dependent on the thickness of the sample. The 4 different kind of car seat cover samples are sandwiched with the highest permeable foam A3 and again moisture permeability tested with upright cup method (ASTM E 96-66) for water vapor permeability.



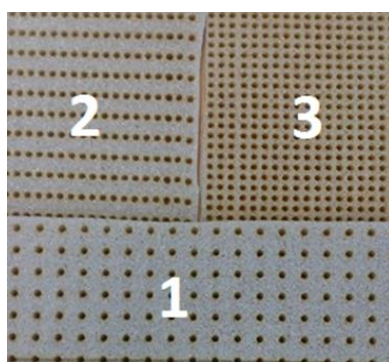
Figure 13 Water vapor permeability of sandwich car seat cushion.

Figure 13 shows the overall permeability of the car seat cover with the foam A3, it can be seen that there is nearly 20-30g of moisture transfer each hour which is almost equal to an average human perspiration during driving. The top layer with 3D spacer fabric showed better

transportation of moisture. In this research the most common top layers are taken from the industry.

### 5.2.2 Perforation in foam using Laser technology

Fine holes are made through the PU-foam using Flexi-CO<sub>2</sub> laser device and different number of holes per unit area are made with same hole size to improve the breathability of the foam. The action of a laser causes physical and chemical changes to polymer surfaces. In this research the PU-foam for Car seats is obtained from company Johnson Control, Czech Republic. The PU-foam layer is used always between the face cover and the cushion of the seat. Initially the basic properties like air permeability and water vapour permeability of specimen are tested using FX3300 and SDL-sweating guarded hot plate respectively. The final product after perforation with LASER is shown in figure 14



**Figure 14 Thin PU foam with different density of perforation by LASER**

The holes are made in the PU- foam with these parameters shown in table 7.

**Table 7 Holes dimension by Laser**

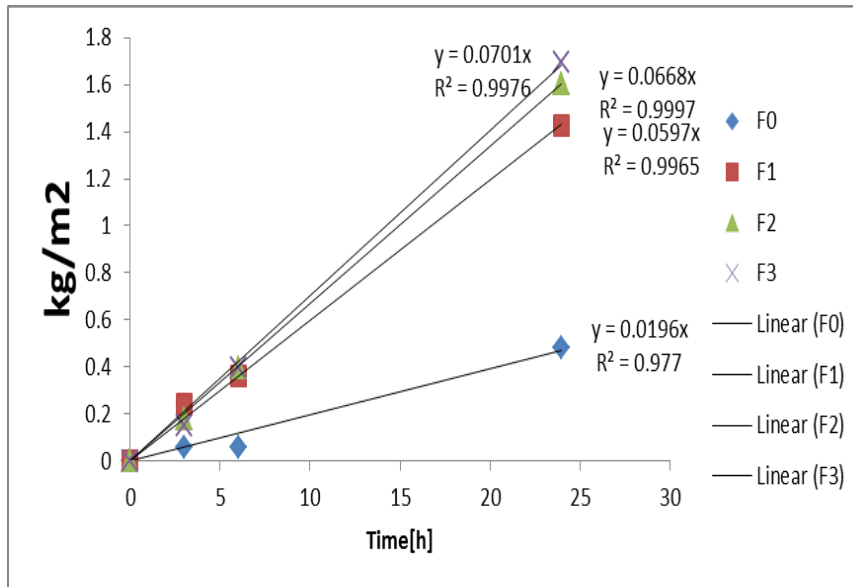
Foam layers name	size of holes [mm]	Number of holes[n/cm <sup>2</sup> ]
0 (no holes)	0	0
1	2.5	4
2	2.5	6
3	2.5	9

The air permeability is measured using machine SDLMO21S by standard ISO9237 shown in table 8.

**Table 8 Permeability of perforated foam at different pressure differences**

Pressure [pa]	Foam Layers permeability [mm/sec]			
	0	1	2	3
1	17	30	55	77.5
1.5	25	45	78	100
2	35	58	98	135
3	55	83	130	188

The moisture permeability is measured by standard Cup Method and shows a direct linear relation between density of holes and the water vapour permeability as shown in figure 15.



**Figure 15 Effect of perforation on the water vapour permeability**

This shows that permeability of PU foam can be improved by laser application. The effect of the structure change on compressibility and life time of this modification will be examined in the other chapter.

### 5.3 Super absorbent fibres (SAF)

Super absorbent fibers (SAF) or super absorbent fibrous material are popular from last decade to absorb and retain high amount of liquids (nearly 300 times its own weight).

The SAF are famous of absorbing and retaining huge amount of liquid but moisture absorption and desorption is still undiscovered property of the SAF. In this research firstly the

absorption and desorption properties of the SAF layers are measured. Then the most efficient SAF is used in between the car seat layers to observe the effect of superabsorbent in the car seat assembly. The measurement is performed by Cup Method (ASTM E 96-66) for moisture permeability.

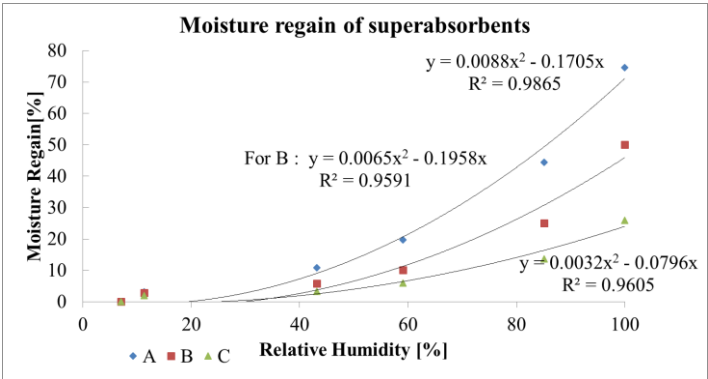
**5.3.1 Absorption desorption isotherm**

The isotherm were obtained by the desiccator method, where the specimen are put in the sealed container having different amount of different saturated salt solutions until weight equilibrium could be assumed. Different salts are used to obtain required humidity level in sealed containers. Table 9 shows the relative humidity (RH%) obtained in different sealed container at 20°C.

**Table 9 Salt solution and RH% in closed containers**

	Salt solution	RH%
1	Distil water	100
2	Potassium chloride	85.1
3	Sodium bromide	59.1
4	Potassium carbonate	43.2
5	Lithium chloride	11.3

The specimens are pre dried at 7% RH for the absorption/desorption isotherm experiment. The specimens are weighed after every 4 days. Each container contains 4 samples; A, B, C and P (PU-foam). Each set of container (5 containers with different percentage of humidity level) are opened after 4, 8 and 12 days in lab condition of temperature 20°C. Weighing the samples after different days will provide us the information if the material is still absorbing the moisture, if there is no difference of moisture gain from the last set of measurement then it will be considered as the maximum moisture absorbed by the sample.



**Figure 16 Moisture absorption with respect to time**

It is observed that the SAF absorbed nearly 70% moisture in with respect to their weight at 100%RH. Specimen “A” showed the highest rate of moisture gain measured after 12 days. The process of testing the samples at different salts providing different humidity levels is quite slow but provides accurate results.

The PU- foam sample gained less than 2% of moisture after 12 days.

**5.3.2 Climate chamber measurement**

The absorption and desorption of samples are also tested in the climate chamber where temperature is set as 20°C and the RH is changed from 7% to 95%. The absorption and desorption of the specimen are calculated. Each samples weighed inside the chamber after every 1 hour. This experiment gives valuable information regarding the time and efficiency of absorption and desorption of specimens. The experiment is repeated 3 time

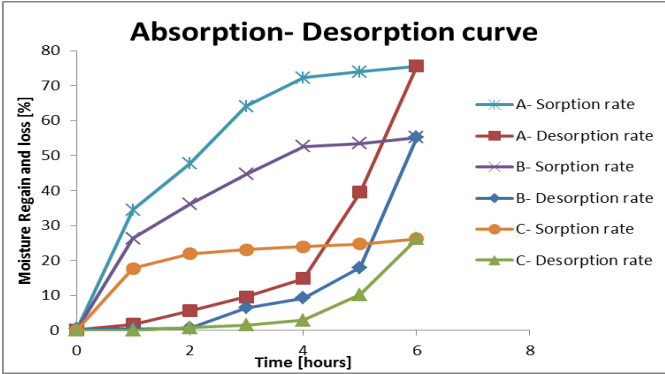


Figure 17 Rate of absorption and desorption

**Standard Upright cup method**

Standard Upright cup method or Gore cup method (ASTM E 96-66) is used to analyse the overall loss of water from the reservoir. The car seat cover material with classic layer structure of X,Y, Z and P is firstly analysed and then the SAF layer is inserted between layer X and Y to determine the effect of SAF layer on the complete sandwich material. Layer P is a thick PU-foam and is well-known for being impermeable and act as moisture barrier from back side of the sandwich material. The PU-foam protect the SAF not to absorb moisture from the chamber environment so results of Cup method would be precise as flow of moisture will be only from the top Layer “X”. The visual illustration of the samples is shown in figure 16.



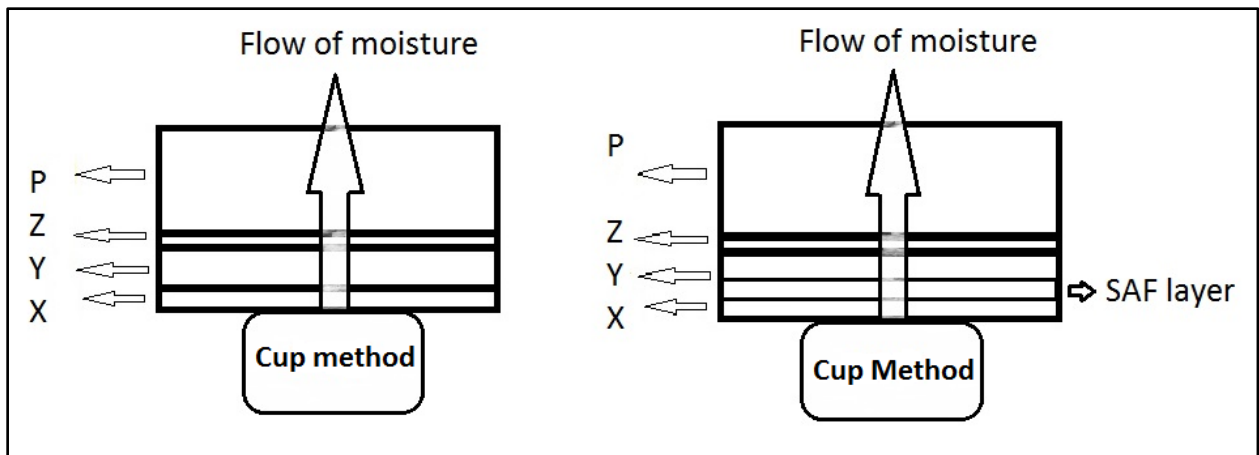


Figure 18 Visual Illustration of specimen layers during Ret testing.

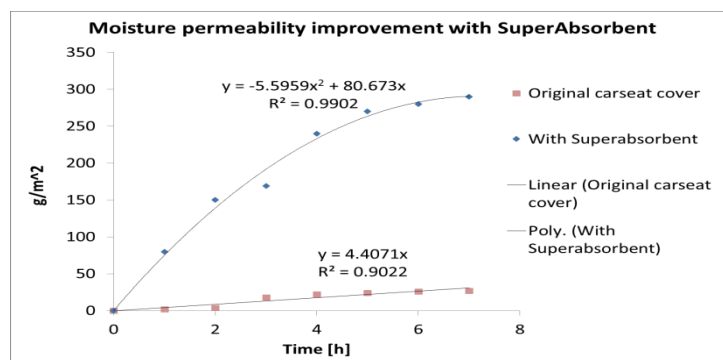


Figure 19 Effect of superabsorbent on moisture permeability

As shown in figure 19 it is observed that the material becomes highly breathable for the first 4 hours of the testing and after that it is still much better than the original sample's breathability. The experiment is repeated 3 times and average values are shown in the graph. The results show a significant difference of moisture transport when superabsorbent is used.

#### 5.4 Compressibility properties of the novel designs

The compression properties of the car seat cover govern the lifetime and durability of the car seat. It is necessary to know how the new and modified material will behave after repeated loading (the sitting and standing action of the driver). It was thought that the making holes to the foam might affect the overall compression properties of the layer and can decrease the life time of the seat materials. All the samples are tested under the compression tester using the Instron machine in which the program was set to run 40,000 cycles for first set of top layers and then a second set of perforated PU-foam undergoes 10,000 cycles of compression keeping the constant load on the sample of 13kPa (this value is obtained experimentally), as the material is compressible so it was necessary to program the machine to load the material

constant pressure even when thickness is changing. For compressibility test the servo-electric loading machine Instron E3000 was used. 40,000 repeated load was performed on the seat cover material and 10 000 loading cycles was performed for perforated foams respectively with frequency 0.5 Hz.

The effect of repeated loading of 20,000 and 40,000 cycles is shown in the figure 20 and 3D spacer shows better properties even after 40,000 cycles of repeated loading of 13kPa.

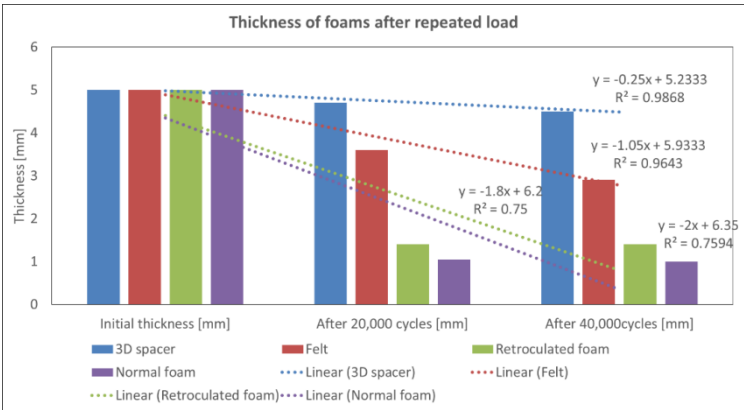


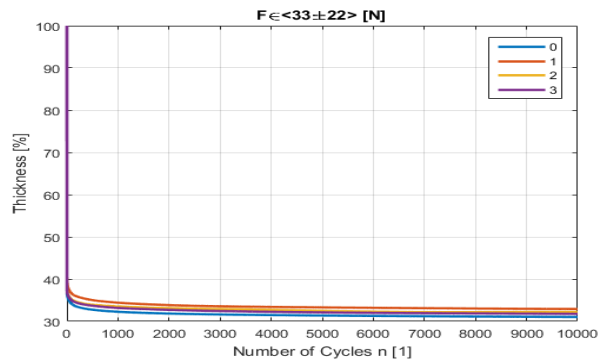
Figure 20 Compressibility properties of the car seat cover

Secondly the testing of the PU-foam with perforation was also tested, these holes are made using a laser technology and properties of the foams are shown in table 10.

Table 10 Breathability of the perforated foam by LASER

Foam layers	size of holes [mm]	Number of holes[n/cm2]	Air permeability [l/m <sup>2</sup> /s] (std.dev)	Water vapour permeability [Pa.m <sup>2</sup> .w <sup>-1</sup> ] (std.dev)
0	0	0	76 ( ± 3 )	27( ± 1.2 )
1	2.5	4	980( ± 15 )	12.7( ± 0.8 )
2	2.5	6	1267( ± 22 )	11.3( ± 0.7 )
3	2.5	9	1920( ±18 )	8( ± 0.3 )

The breathability of the material were tested after perforation and shows significant improvement of air and moisture permeability due to perforation, the maximum is observed for the Sample 3, with the highest density of the holes per unit area. The Perforated PU foams showed better air and moisture permeability but the compressibility property and the life time is a very important factor to consider while making car seat covers. In this experiment the repeated load of 13kpa was applied using Intron tester and this loading and unloading is repeated for 10.000 times.



**Figure 21** Effect of repeated loading on the thin PU foam (Y)

The figure 21 clearly shows that all foam loses nearly 60% of their thickness during the first 500 cycles and after that the PU foam maintain its shape and even there is a negligible difference till 10000 repeated cycles. The result is very important as there is insignificant difference between each PU foam layer irrespective of the number of holes in it, this gives a great option for the future utilization of perforated PU foams.

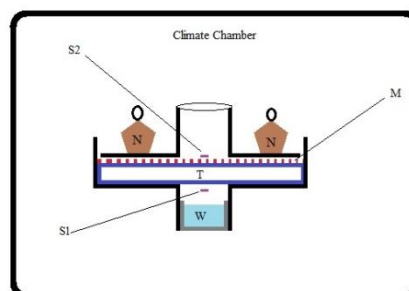
## 5.5 Novel techniques to measure moisture permeability

Initially thermal cameras and self made sensor sheet is used to have a thermal and humidity field in the microclimate. Two devices are also self fabricated to advance in the measurement of comfort of textile seat. The working principle and results of one device is shown here.

### 5.5.1 Measurement of moisture permeability under load

The car seat cover material are compressible material that means that their structure, porosity and thickness changes under load. A driver sitting on a car seat can totally change the defined performance of the car seat material.

A unique modification is made to the classical CUP MEHTOD for testing the moisture permeability with and without load. A self-fabricated frame is used to hold the testing material with a constant pressure on it by using perforated metal mesh.



**Figure 22** schematic diagram of the measuring device under load

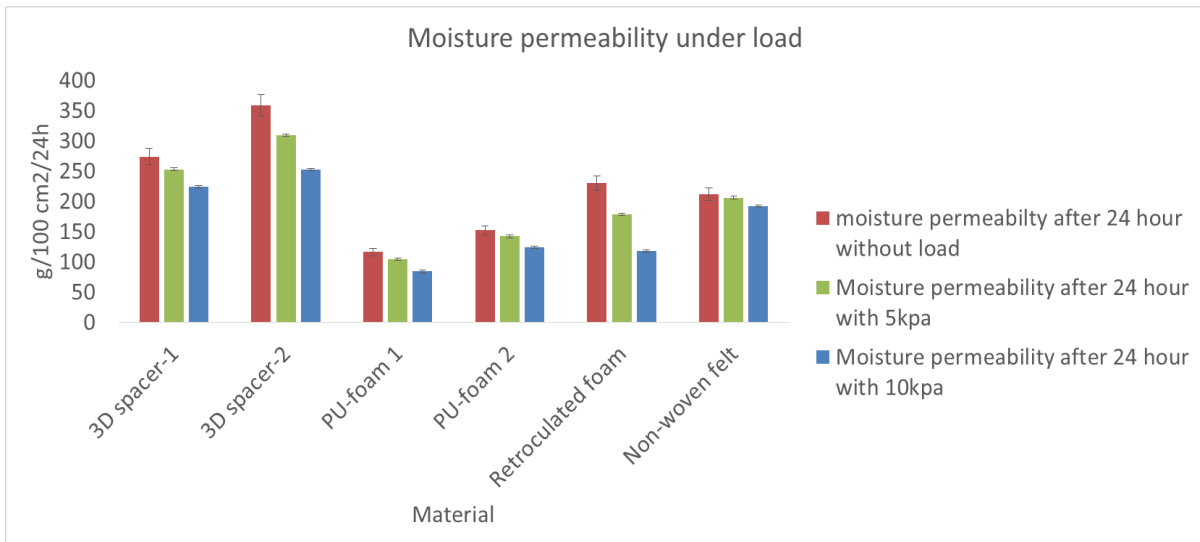
Where  $W$  is distilled water for moisture source  
 $T$  is the car seat cover material  
 $N$  is the load on the sample  
 $S1$  and  $S2$  are the humidity sensors  
 $M$  is a porous sheet on the sample to apply even pressure.  
 Calculation of the water vapour transmission, and permeability is as follows.  
 $WVT = G/t.A$  Eq.5  
 $G =$  weight change, g  
 $t =$  time, h  
 $A =$  test area,  $m^2$   
 $WVT =$  rate of water vapour transmission,  $g/h \cdot m^2$

The experiment is performed in climate chamber with a controlled environment according to standard ASTM E 96-66. The sample properties are shown in table 11.

**Table 11 Sample properties**

Sample	thickness [mm]
3D spacer-1	10
3D spacer-2	3
PU-foam 1	6
PU-foam 2	3
Retroculated foam	3
Non-woven felt	3

To see the effect of the pressure on the moisture permeability, the car seat material are tested with and without loads. The moisture permeability of different car seat material under two different pressure (5 and 10kpa) and without pressure is shown in figure 23.



**Figure 23 Moisture permeability under load**

The figure 23 shows that there is a significant effect of pressure on the permeability of the car seat material. This test method is unique and can show us experimentally how material behaves under load. It is visible that there is a significant decrease of moisture permeability when there is pressure on the car seat cover, which can be because of the closing of pores due to the pressure. All the materials are affected by the pressure but the permeability of 3D spacer is still higher as compared to any other material even after loading.

## **5.6 Theoretical Model: Analysing theoretically the air flow through car seat foam material**

Air permeability describes the rate of flow of a fluid through a porous material, and the mathematical expression is given by

$$q = Q / At \quad \text{Eq.1}$$

Where  $q$  is rate of flow (m/s),  $Q$  is volume of flow of fluid through the sample ( $m^3$ ),  $t$  is time (s) and  $A$  is the cross-sectional area ( $m^2$ ).

Textile material stand out as a unique class of porous media, which contain relatively high volume of air and very complex structure due to the random arrangement of fibres or pores. Air permeability is one of the most important properties of textile materials in many applications, Numerous researchers have worked on the air permeability of non-woven fabrics in both experiment [10-12] and analytical prediction [13-15] Darcy derived an equation for calculating the air permeability based on hydraulic radius theory[16], which states that rate of flow is directly proportional to the pressure gradient causing the flow. The equation is as follows:

$$Q = A.t.(K_p. \Delta P) / (\mu.L) \quad \text{Eq.2}$$

Where  $Q$  is the rate of flow (m/s),  $K_p$  is the flow permeability coefficient ( $m^2$ ),  $\Delta p$  is the pressure gradient (pa),  $\mu$  is the viscosity of the flow ( $pa \cdot s$ ),  $L$  is the thickness of sample (m),  $Q$  is the volume flowing in time ( $m^3$ ),  $A$  is the cross-section area ( $m^2$ ) where flow goes through,  $t$  is time (s).

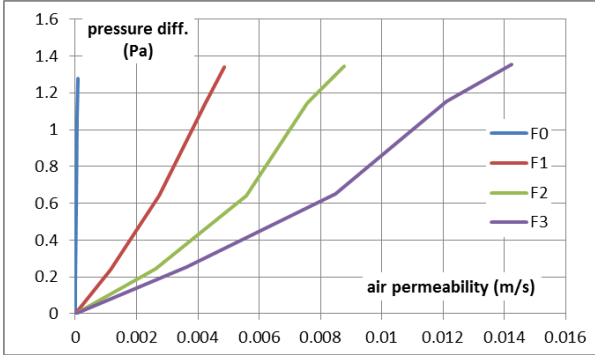
As explained in the literature review part that the air flow and the water vapor permeability are the connected properties. This gives us the idea to theoretically analyse the flow of air through the textile layers and predict the performance of the car seat materials

The Air permeability of the samples are tested under different pressure difference by standard method ISO standard 9237. Results are shown in table 12. It is quite obvious that the PU-foam without holes is almost impermeable and the flow increases with the size of hole.

**Table 12 Air permeability at different pressure**

Press. [Pa]	Unit [mL/sec]			
	F0	F1	F2	F3
1,1	0,2	19	43	60
1,5	0,6	45	92	140
2	1,1	70	125	200
2,2	1,25	80	145	235

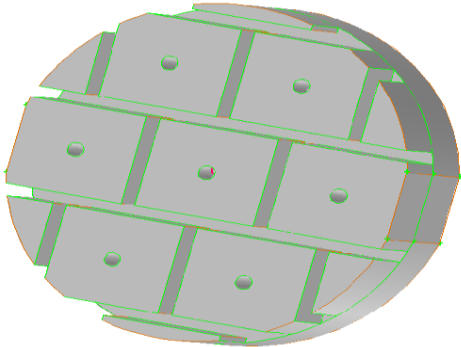
Permeability of the classical foam (F0) is 64-188 times lower permeable than cases F1-F3 as shown in figure 24.



**Figure 24 Air permeability at different pressure**

The permeability of the observed layer is given by its flow resistance. This resistance consists in general from the linear term, typical for instance for small velocities (so-called Darcy’s law) and from the quadratic term, typical for flow around bodies or through channels (Weissbach’s or Moody’s law)

The basic model of the numerical simulation was designed and the software was run with the input equation and the parameters from the experimental results. The basic model is shown in figure 25.



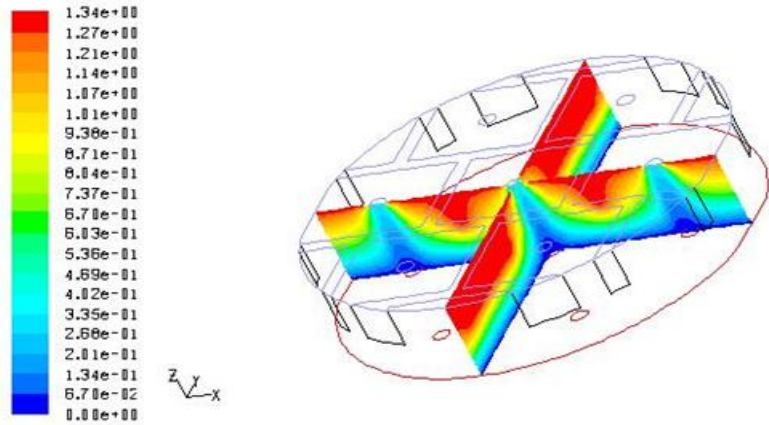
**Figure 25 basic model of numerical simulation**

The main results of the numerical simulation are shown in the table 13. Differences between flows of inlet and outlet are not important. Even if the holes area is 1,1% of the total area of sample, the main flow is going through holes and the flow through the foam material is less than 1% approximately. It could be stated that the foam is practically impermeable and used as compressible cushion.

**Table 13 Inlet and outlet prediction of low**

		area		mass flow		measured
		m <sup>2</sup>	%	kg/s	%	kg/s.
inlet	foam	0.012858	78.2	0.92794e-6	0.3	
	grooves	0.003415	20.8	2.24480e-6	0.8	
	holes	0.000178	1.1	2.80000e-4	98.8	
	sum	0.016452		2.83300e-4		0.415e-4
outlet	foam	0.016273	98.9	2.07184e-6	0.7	
	holes	0.000178	1.1	2.81000e-4	99.2	
	sum	0.016451		2.83300e-4		0.415e-4

Next serial of flow fields presents main qualitative results. To get full details of individual flow fields different scales are used. The model is shown with different graphical representation.



**Figure 26 Pressure field – axial cross sections**

Hypothesis for this part of the model is that if the foam is pressed then the foam volume by 50% in the flow direction. The inner permeable cells are also pressed by 50% too. For simple verification the model geometry remains the same. New parameters of permeability are determined as in the table 14 from the condition of 50% of measured flow.

**Table 14 Permeability parameters for 50% flow (due to foam pressing)**

	C2	$\alpha$ (m <sup>2</sup> )	1/ $\alpha$ (1/m <sup>2</sup> )
F0	1.111E+10	7.052E-12	1.418E+11

Results are summarized in the Tab. 15 where original mass flows through foam and grooves is decreased by 28% and 27% respectively of original values. It means from 1% of the whole flow to 0.3% approximately. It has not any influence on the flow through holes, as it represents 99% of the whole flow and some small flow changes in foam and grooves does not have any influence.

**Table 15 Prediction of flow under compression**

		original		pressed	
		kg/s	%	kg/s	%
inlet	foam	0.92794e-6	0.3	2.6134e-7	28.2
	grooves	2.24480e-6	0.8	6.0319e-7	26.7
	holes	2.80000e-4	98.8	2.8160e-4	100
	sum	2.83300e-4		2.8247e-4	99.7
outlet	foam	2.07184e-6	0.7	5.5473e-7	26.8
	holes	2.81000e-4	99.2	2.8190e-4	100
	sum	2.83300e-4		2.8247e-4	99.7

## 6 Evaluation of results and new findings

It can conclude from our research that:

Highly permeable top layers alone cannot improve the overall breathability of the car seat. The problem zone for the breathability will be always the PU-foam and the lamination. The focus should be to use the breathable layer with improvement to the lamination and the PU-foam for better permeability. The car seat comfort should be evaluated considering overall car seat, not just the top layer.

In this research 3D spacer fabric are compared with commonly used PU foams the non-woven materials, results shows that 3D spacer fabric shows a great improvement for the car seat thermal comfort. Use of 3d Spacer fabric can reduce the number of layers of car seat cover, as more number of layer negatively affect the thermal comfort of the car seat. High variety of



thickness of the 3D spacer fabrics gives opportunity to be used as car seat cover as well as cushion part of the car seat.

The classical PU-foam were replaced by the molded perforated foams for the cushion part and the Pu-foam for the interlining are perforated by LASER technology. Significant improvement in the breathability of the car seat was observed. The perforated foams can be future replacement for the classical foams. Different design of grooves and shapes of holes can also be introduced to increase the porosity of the foams.

The use of super absorbent polymers (SAP) for moisture absorption and comfort is studied. In this research the efficiency of different SAP fibrous webs are determined under different moisture percentage to examine the sorption and desorption efficiency. The SAP fibrous web with low thickness and high moisture absorption are tested with multilayer sandwich structure of car seat cover to determine the moisture absorption through cover material. It is observed that the SAP fibrous layers are very effective in absorbing and desorbing water vapour under high and low moisture percentages. The superabsorbent material are efficient to absorb and desorb water vapour and 50% and higher rate of absorption can be easily achieved under extreme humidity level. The fast sorption and desorption process can be repeated multiple times and make it potential use in the comfort of car seat. The research is initial work to see the utilization of superabsorbent in car seat. This is novel and initial work and further research will be done regarding the life time of the SAF in car seats.

To determine the compression results it was necessary to find the exact pressure inserted by the human on the car seat. This pressure value was obtained from the pressure distribution experiment by X-Sensor device as 13 kPa and this value was further used for the compressibility and life time testing of the car seat materials. Results shows that the 3D spacer fabric shows better in retaining its thickness even after multiple loadings.

The research work shows that there is significant improvement of the breathability of car seat's PU foam due to the perforation. The hole sizes effectively help in the transfer of air and moisture and shows a huge increase in permeability of the material. The effect of this perforation was also tested for the compressibility properties of the PU foam and it was observed that there is insignificant effect of perforation on the thickness of foam. The research work is unique for providing an alternative for better comfort of car seat with negligible effect on the usability or life time of car seat.

In this research multiple novel techniques/devices are made to test the comfort properties of the car seat. Firstly thermal camera is used to analyse the real time thermal field of the car seat and see performance of interface heating of the car seat. Secondly a sensor sheet is made to analyse the humidity and temperature field of the car seat during usage. Thirdly the classical Cup Method is modified to analyse the permeability of the material under different pressures. Lastly a unique portable device is made to measure the water vapour permeability of the real car seat.

The air permeability of different geometry of the perforated foams are tested with different pressure. The initial experimental results is used to develop a theoretical model to simulate the air permeability of perforated foams. The percentage difference of the experimental and the theoretical results shows less than 5%. This model can be used for predicting the air permeability of PU foam under different load and different geometry of perforation.

## 7 References

- [1] K. Slater, Human Comfort, Thomas Publisher, Springfield, IL, USA. (1985) 4.
- [2] A. K. R. Choudhary, P. K. Majumdar and C. Datta, Factors affecting comfort: Human physiology and role of clothing, improving comfort in clothing, Wood Head Publishing. (2011) 1-57.
- [3] I. Jerkovic<sup>1</sup>, J. M. Pallares, X. Capdevila, STUDY OF THE ABRASION RESISTANCE IN THE UPHOLSTERY OF AUTOMOBILE SEATS, AUTEX Research Journal, Vol. 10, No1, March 2010
- [4] Environmental Aspects, Recycling. Shiramizu, K. Toyota. Environmental & Social Report, 2005. [http://www.toyota-global.com/sustainability/report/sr/05/pdf/eco\\_04.pdf](http://www.toyota-global.com/sustainability/report/sr/05/pdf/eco_04.pdf)
- [5] E. SÖDERBAUM, Requirements for automotive textiles – a car producer’s view, Textile advances in the automotive industry, Woodhead Publishing in Textiles: Number 79, 3-15, 2008
- [6] Bartels, VT. Physiologically optimized car seats, in *Textile Advances in Automobile Industry*, Woodhead Publishing. 2008, pp.150-170. ISBN: 9781845693312
- [7] K. H Umbach , Physiologischer Sitzkomfort im Kfz’, *Kettenwirk-Praxis*, 34 (2000a) 34–40.
- [8] Umbach, KH. ‘Parameters for the physiological comfort on car seats’, 38th International Man-Made Fibres Congress, Dornbirn, Austria. 1999,
- [9] Martin W. Ferguson-Pell, Seat Cushion Selection, *Journal of Rehabilitation Research and Development Clinic Suppl.* 1990, Vol.2, pp.49-73.
- [10] Kothari, VK. and Newton, A. Air-Permeability of Nonwoven Fabrics. *Journal of the Textile Institute*, 1974, Vol.65(10), pp. 525-531.
- [11] Mohammadi, M. and Banks-Lee, P. Air permeability of multilayered nonwoven fabrics: Comparison of experimental and theoretical results. *Textile Research Journal*, 2002. Vol.72(7), pp. 613-617.
- [12] Debnath, S. and Madhusoothanan, M. Thermal resistance and air permeability of jute-polypropylene blended needle punched nonwoven. *Indian Journal of Fibre & Textile Research*, 2011. Vol.36(2), pp. 122-131.
- [13] Kulichenko, AV. Theoretical analysis, calculation, and prediction of the air permeability of textiles. *Fibre Chemistry*, 2005. Vol. 37(5), pp. 371-380.
- [14] Mohammadi, M. and Lee, PB. Air permeability of multilayer needle punched nonwoven fabrics: Theoretical method. *Journal of Industrial Textiles*, 2002. Vol.32(1), pp. 45-57.
- [15] Song, WF and Yu, WD. Fractal calculation of air permeability of nonwoven fabrics. *Journal of the Textile Institute*, 2012, Vol. 103(8), pp. 817-826
- [16] Adámek, K. Prodyšnosť textilných vrstev“, XV. mezinár. konf. Aplik. exp. a numer. metód v mech. tekutín, ŽU Žilina, 2008

## 8 List of papers published by the author

### 8.1 Publications in journals

1. **Mazari, Funda Buyuk**, Mazari A, Havelka A, Wiener J. Effect of a Superabsorbent for the Improvement of Car Seat Thermal Comfort. *FIBRES & TEXTILES in Eastern Europe* 2017; 25, 2(122): 81-85. DOI: 10.5604/12303666.1228187 (Impact Factor:0.7)
2. **Mazari, Funda Buyuk**, Michal Chotebor , Adnan Mazari , Jawad Naeem, Antonin Havelka, Effect of Perforated Polyurethane Foam on Moisture Permeability for Car Seat Comfort, *Fiber and textile in Eastern Europe*, Vol (26), 6(120),14-18 2016(Impact Factor:0.7)
3. **Mazari, Funda Buyuk.**, Havelka, Glombiková, V., Mazari Adnan, Novel portable device to analyze the moisture permeability of car seat, *Industria textile*, ISSN 1222–5347/2017, 2/2018 ( Impact factor 0.5)
4. **Mazari, Funda Buyuk.**, Havelka, A. Pressure distribution of car seat at different angle of backrest. *Vlakna a Textil* 2015 (3-4), pp. 33-39 (SCOPUS)
5. Havelka, A., Glombiková, V., **Mazari, Funda Buyuk.**, Monitoring thermophysiological comfort in the interlayer between driver and the car seat. *Fibers and Textiles*, 2015 (3-4), pp. 40-45 (SCOPUS)
6. **Mazari, Funda Buyuk.**, Naeem, J., Mazari, A., Instruments used for testing moisture permeability, *Fibers and Textiles*, 42-47, 1,2016. (SCOPUS)
7. **Mazari, Funda Buyuk**, David Cirkl, Antonin Havelka, Jakub Wiener. Effect of mechanical pores on the breathability and compression properties of Poly-Urethane foams for car seat's cover. *Industria textila*, under process. (Impact Factor:0.5)
8. Zhu, G., Kremenakova, D., Wang, Y., Militky, J., **Mazari, Funda Buyuk.**, An analysis of effective thermal conductivity of heterogeneous materials, *Autex Research Journal*, 2014, 14 (1), pp. 14-21( Impact factor 0.6)
9. Mangat,A., Bajzik, V., Hes, L., **Mazari, Funda Buyuk.**, The use of artificial neural networks to estimate thermal resistance of knitted fabrics, *Tekstil-ve-Konfesiyon*, volume:25, 2015(4) , pp. 304-312.(impact factor 0.5)

10. **Mazari, Funda Buyuk**, Adamek Karel, Antonin Havelka, Theoretical analysis of air permeability through car seat's PU foam. *Fiber and Polymer*, 2017 Under process.
11. **Mazari, Funda Buyuk**, Havelka Antonin, Hes Lubos, Comparison of different top layers of car seat's cover. *Fiber and Textile in Eastern Europe*, Under process.
12. Mangat, A., Hes, L., Bajzik, V., **Funda, B.**, Model of Thermal Absorptivity of Knitted Rib in Dry State and its Experimental Authentication, *Industria Textila*, Vol.68,no.4, ISSN 1222–53472017, 263-268

## 8.2 Contribution in conference proceeding

- 1) Funda Buyuk Mazari and Antonin Havelka, Comfort of car seats, 7th International conference, 10-11 Nov 2016, 329-333, Albania.
- 2) Improvement of car seat's thermal comfort, Funda BuyukMazari, Antonin Havelka, Adnan Mazari & Jakub Wiener, 16th International Autex Conference,8-10 June, ISBN 978-961-6900-17-1, Slovenia 2016
- 3) Funda Buyuk Mazari and Antonin Havelka, Jakub Wiener, Adnan Mazari, Application of Super Absorbent Microfiber for carseat's comfort, NART conference, Liberec, 2017, ( web of science)
- 4) Funda BuyukMazari, Antonin Havelka, A study on the perforated Poly-Urethane foam for the car seat, *Strutex*, ISBN 978-80-7494-269-3, Dec 1-2, Liberec. 2016.
- 5) Funda Buyuk Mazari, Adnan Mazari, Michal Chotebor and Antonin Havelka, A study on heat and mass transfer through car seat poly-urethane foam, 15 Autex Conference, Bucharest, Romania, 2015.
- 6) Mazari FB, Mazari A and Havelka A pressure distribution of car seat under different angle of back rest, ISBN:978-80-7494-139-9, *Strutex*, Liberec 2014.
- 7) Mazari FB, Havelka A and Mazari A, A novel technique to measure the water vapour permeability under different loads,ISBN:978-80-7494-139-9, *Strutex* , Liberec 2014

- 8) Funda Buyuk Mazari , Antonin Havelka , Adnan Mazari & Jakub Wiener, Application of Super Absorbent Fibrous Materials for improving Car Seat Comfort Advances in material engineering, Liberec, 1-2 December 2015
- 9) Funda Buyuk Mazari and Antonin Havelka, Durability and comfort of car seats, TRS45, Japan, 14-16.10.2017

### **8.3 Quotation**

**12 articles** are available in the database of Scopus, **5 articles** are published in Impact factor journals (Web of Science/Thompsons Reuters).

**Name :** Ing. Funda Büyük Mazari

**Address:** Jestedska 341, 46008 Liberec.

**E-mail:** [fundabuyuk@hotmail.com](mailto:fundabuyuk@hotmail.com)



Objective		
A prospect to work at a high ranked research based university where I can use my knowledge for some useful work for the industry and gain experience and knowledge from the university researchers and teachers.		
Personal Details		
Marital status	Married	
Date of Birth	14 September 1987	
Languages	Fluently speaks English, Turkish	
Qualifications	Excellent academic records	
Work experience		
Position	Company	Date
Merchandiser (Marketing)	Fetih Textile,Istanbul,Turkey	February 2011-September 2011
Educational Qualifications		
Degree	University	Year
Ph.D. in material Engineering	Technical University of Liberec, Czech Republic	In progress
Master in Textile engineering	Technical University of Liberec, Czech Republic	2011-2013
Student Exchange program for textile Engineering	Technical University of Liberec, Czech Republic	2009-2011(January)
Bachelors of Textile Engineering	Pammukale University ,Denizli, Turkey	2007-2011
IT Knowledge		
Excellent English and Turkish for writing business letter and emails. Microsoft Office (expertise in Microsoft Excel, Word, Powerpoint) & outlook. MATLAB		
Courses and Achievements		
Marketing Training at Yiltex company Turkey. Personality behaviour analysis course from Istanbul, Turkey Marketing merchandiser at Fetih Textile.		
Research Interest		
Innovative and international research to bring advantage to the field of textile.		
Hobbies		
Travelling, making friends, learning different languages, learning different cultures and their food.		
References		
Prof, Jiri Militky,CSc Doc. Antonin Havelka,CSc		

## Brief description of the current expertise, research and scientific activities

I am actively involved at research related to clothing production, sewing machines, clothing comfort, car-seat comfort and designing special testing equipment for the testing of car seat comfort under dynamic loads. I have successfully passed all exams related to my Ph.D. studies.

### Doktorské studium

Studium                      Doctoral study programme Textile Engineering in a full-time form at the Faculty of Textile Engineering, Technical University of Liberec.

#### Seznam zkoušek

	Heat and Mass Transfer in Porous Media	16.12.2013
	Structural Theory of Fibrous Assemblies	21.11.2013
	Numerical Methods	21.03.2014
	Transport Phenomena of Forming	28.1.2014
	Experimental Technology	18.11.2015
SDZ	Comprehensive Doctoral Exam	13.06.2016

**Pedagogická činnost**      Taught multiple courses for the international Erasmus students like

- **Textile technology**
- **Clothing production**

### Výzkumné projekty

Research Leader for three SGS projects for year 2015

Researcher in the Project from Department of Clothing, TUL, Czech Republic.



## Record of the state doctoral exam



# ZÁPIS O VYKONÁNÍ STÁTNÍ DOKTORSKÉ ZKOUŠKY (SDZ)

Jméno a příjmení doktorandky: **Ing. Funda Büyük Mazari**

Datum narození: **14. 9. 1987**

Doktorský studijní program: **Textilní inženýrství**

Studijní obor: **Textile Technics and Materials Engineering**

Termín konání SDZ: **13. 6. 2016**

**prospěla**

**neprospěla**

Komise pro SDZ:

Podpis

Předseda:	prof. Ing. Luboš Hes, DrSc., Dr.h.c.	
Místopředseda:	prof. Ing. Jakub Wiener, Ph.D.	
Členové:	prof. Ing. Karel Adámek, CSc.	
	prof. Dr. Ing. Zdeněk Kůs, CSc.	
	doc. Ing. Vladimír Bajzík, Ph.D.	
	doc. Ing. David Cirkl, Ph.D.	
	doc. RNDr. Miroslav Šulc, Ph.D.	

V Liberci dne 13. 6. 2016

O průběhu SDZ je veden protokol.



## Recommendation of the supervisor

Stanovisko školitele k obhajobě disertační práce Ing. Fundy Mazari.

Na téma „ **Studie komfortu a termo-fyziologických vlastností autosedaček.**

Ing. Funda Mazari zpracovala výše uvedené téma v rámci systematické vědecké práce na zadané problematice komfortu automobilových sedaček, jako důležitému aspektu kvality řízení a soustředění při provozu automobilů. V práci zkoumala faktory ovlivňující prodyšnost vzduchu autosedaček v celé soustavě jednotlivých vrstev, což dokladuje řadou experimentů s PU pěnou. Teoretické výsledky porovnává s hodnocením skupiny probandů. Pro posouzení kvality proudění byl vytvořen model proudění vzduchu v programu „ Fluent“, což dokladuje vliv tvaru drah proudění v sendvičové struktuře autosedačky a transportních jevů proudění vzduchu a vlhkosti pro zachování nezbytného komfortu sezení. Výsledky vědecké práce doktorandka prezentovala na řadě konferencí, a v řadě publikací 4x v impaktovaných časopisech 6x rec. časopis.

Ing. Funda Mazari pracovala na zadaném tématu systematicky a zodpovědně a vždy plnila řádně všechny studijní povinnosti doktoranda TUL. Cíle práce jsou zpracovány tak, že doporučuji doktorandskou práci na téma „ Studie komfortu a termo-fyziologických vlastností autosedaček“ k obhajobě.

  
Doc. Ing. Antonín Havelka, CSc. školitel

V Liberci 8/05/2017

## Opponent's reviews

### Posudek disertační práce

Název práce: **Studie komfortu a termo-fyziologických vlastností autosedaček**  
Autor: **Ing. Funda Büyüik Mazari**  
Oponent: Prof. Ing. Karel Adámek, CSc.

Předložená anglicky psaná disertační práce obsahuje na 150 stran s mnoha obrázky a tabulkami v textu. Je uvedeno 17 vlastních publikací ve spolupráci s dalšími autory v mezinárodních časopisech a na mezinárodních konferencích, které mají vztah k tématu disertace. Dále je uvedeno na 100 odkazů na další prameny. Práce je logicky a přehledně členěná v obvyklém schématu.

Hlavním tématem práce je studie komfortu autosedaček, především s ohledem na jejich prodyšnost pro vzduch a propustnost pro páru. Vzhledem k obrovskému množství vyráběných automobilů je každé zlepšení komfortu přínosem.

Rozsáhlá kap. 1 uvádí poznatky z rešerší, související s tématem práce, kap. 2 a kap. 3 heslovitě definují problémy k řešení – vliv různých materiálů na komfort autosedačky, experimenty na reálných sedačkách, testování pěnových materiálů PU a několik hlavních cílů k řešení.

V kap. 4 je popis materiálů sedaček, které byly použity pro experimenty a příslušného přístrojového vybavení.

V kap. 5 jsou uvedeny a testovány faktory, které ovlivňují prodyšnost. Výsledky jsou v souhrnných grafech – potvrdilo se očekávání, že laminování zhoršuje prodyšnost, větší tloušťka pěny zvětšuje tepelný odpor atd.

V kap. 6 se hledají možnosti, jak zlepšit celkový komfort při používání sedačky. Výsledky jsou opět shrnuty do přehledných společných grafů. Kromě různých povrchových vrstev, děrované pěny atd. je zde uvedeno několik užitečných poznatků, na příklad že nejlepší jsou 3D textilní konstrukce. *Proč se nepoužívají? Drahé to asi nebude, možná se při zatížení trvale deformují? Již před 100 lety byly běžné žíněné matrace na pružinovém roštu a i dnes se takové uspořádání používá jako luxusní výrobek.*

Zajímavá je i aplikace super absorbujících vláken (SAF) – je to perfektní vlastnost k pohlcení vlhkosti, ale *jak se vlhkost pohlcená během provozu dostane ven?*

V kap. 7 je studie stlačitelnosti materiálů, použitých na sedačku, jako další nezbytná provozní vlastnost – trvalá deformace, opotřebení, ztráta prodyšnosti apod. *Jaký je praktický efekt výrazného zmenšení tloušťky po opakovaném zatížení na změnu prodyšnosti?*

Poznámka: Při testování prodyšnosti při zatížení (str. 109) se zátěž na testovaný vzorek přenáší *děrovaným plechem, který má také nějaký průtokový odpor, který se počítá s odporem testované vrstvy!*

Kap. 8 uvádí nové techniky pro měření propustnosti páry. Zde mám *připomínku*, která ale není výtkou k této práci, ale k dlouhodobému dvoukolejnému přístupu při stanovení prodyšnosti resp. Propustnosti páry. Proč se používá jiná jednotka pro prodyšnost vzduchu

(ml/m.s) a jiná pro odpor proti propustnosti páry ( $m^2 \cdot Pa/W$ ), když to je oboje totéž a v zákonné soustavě jednotek SI velmi jednoduché, tj. m/s a převrácená hodnota s/m? Disertanti a diplomanti to opisují od ctěných akademiků i navzájem mezi sebou a nikoho nenapadne se nad tím maličko zamyslet.

Zajímavý je přenosný přístroj k nedestruktivnímu měření propustnosti páry (str. 111), který dává logický a srozumitelný výsledek ve  $W/m^2$  – kolik tepla je třeba dodat, aby se udržel rovnovážný stav při průchodu páry přes testovanou vrstvu (plus přes oddělovací celofán!!). Čili není to jednotka prodyšnosti m/s, jaká se používá, ale náhradní veličina, která uvádí, jaký je třeba udržovat standardní tok tepla testovanou vrstvou k úhradě prošlé vlhkosti. *Ale pokud je prodyšnost testované vrstvy mnohem větší než prodyšnost celofánu, měří se pak jen prodyšnost celofánu?*

V kap. 9 jsou uvedeny převzaté výsledky z objednané kontrolní metody k prováděným experimentům – numerická simulace proudění v děrované pěnové vrstvě, používané pro sedačku. Výsledky obou postupů se shodují – pěna je prakticky neprodyšná a slouží jen k příjemnému sezení, prodyšnost dělají především průchozí otvory v pěně, prodyšnost se snižuje laminováním a krycím čalouněním atd. Metoda numerické simulace navíc umožní sledovat detaily proudění v pěně, otvoru či zářezu, na rozhraní otvoru a pěny, atd. - pro téma této práce to asi není důležité.

Ke stanovení parametrů prodyšnosti pro simulaci byly použity změřené podklady (str. 118). Ty uvádějí nulový průtok při nenulovém tlaku - to není fyzikálně možné, resp. chybu 0,9 Pa při velmi malém rozsahu tlaků do 2,0 Pa nelze zanedbat a je třeba najít příčinu – netěsnost, nepřesnost odečtu, necitlivost měřidla v okolí nuly atd.

#### Závěrečné zhodnocení

Přínosem práce je velké množství experimentálních výsledků pro různé testované materiály, které mají svou logiku. Jako nejvhodnější z toho vycházejí 3D textilní konstrukce, bylo by vhodné naznačit, co brání jejich rozšíření?

Stejně jako v jiných diplomových a disertačních pracích je zde shromážděno mnoho užitečných výsledků, tedy především analýza problému, ale následná syntéza je jen velmi stručná - co je příčinou zjištěných jevů, jak to použít v dalším výzkumu a v praxi apod.

*Dotazy a témata pro diskusi v průběhu obhajoby jsou uvedeny průběžně v předchozím textu.*

I přes výše uvedené dílčí výhrady konstatuji, že cíle, zadané pro vypracování této disertační práce byly splněny, práce také splňuje formální požadavky, kladené na disertační práci. Proto ji

#### **doporučuji k obhajobě**

a po úspěšné obhajobě doporučuji udělení akademického titulu PhD.

V Liberci 25.7.2017

  
Prof. Ing. Karel Adámek, CSc.



## Review on Ph.D. thesis

### *A Study on the Comfort and Thermo-physiological Properties of Car Seats*

by Ing. Funda Büyük Mazari

Technical University of Liberec  
Faculty of Textile Engineering

This thesis is broken down into 9 chapters. First one, the largest, presents the outcomes of literature research. They concern properties of textile fibers and structures as air and moisture permeability, thermal conductivity and used experimental methods. They concern also properties of human organism with respect to perception of temperature and thermal conductivity of materials, which are in contact with body. By this the author defines the concept of comfort for the purpose of this thesis and methods used for its evaluation. These methods usually used for evaluation of textiles are applied analogically for evaluation of seats as they are seen as sandwich structures made up from individual layers of textile and structural materials.

Chapter 2 is a brief summary of the state of knowledge of solved problem and sets out the space for work of the author. In chapter 3 there are defined the objectives of the work. In chapter 4 the individual samples of materials and seats used for experiments are described in detail.

In following chapters there are analyzed properties of cover layers and interlining materials, which have influence on air and moisture permeability of seats. The influence of lamination, as a method of joining them together, is investigated as well. There are suggested measures for increase of permeability of PU foam in form of additional perforation with net of small holes, or by application of breathable 3D mesh. For increase of moisture absorption the properties of superabsorbent fibrous web are investigated. The evaluation of the impact of these approaches is supported by many experimental results. The author then put question about influence of these improvements on mechanical properties of materials and concludes that increase of permeability by these ways does not affect them negatively. Properties of seats are measured with sufficient number of 50 persons.

In chapter 8 the author presents novel measurement tool in form of textile layer comprising net of temperature and humidity sensors. This tool is used for evaluation of properties of 4 seats. Furthermore she presents the use of new portable device for measurement of moisture permeability of seats.

In 9-th chapter the last one there is presented theoretical description of air flow through channels. This description is used for obtaining parameters of numerical model. The simulation of air flow through specimen of PU foam with cylindrical holes and air channels is performed in software Fluent.

I have following comments on the work: In the list of symbols on page 21 the letter Q is reserved for volume of flow of fluid through the sample [ $m^3$ ] and the letter q for rate of flow [ $m/s$ ]. But on page 34 the Q is used for denomination of heat conduction and q for heat transferred per unit time [W]. On the same page the derivative of q with respect to time is used for description of heat flux with unit [ $W/m^2$ ]. In equation 6 on page 36 the Q is used for amount of conducted heat with unit [J]. In this equation the physical unit of left side of equation does not match the physical unit of the right side.

The equations are numbered from 1 in every chapter while numbering equation incrementally through all text is the standard.

In case of use of linear regression for approximation of measured data by line the coefficient of determination  $R^2 < 0.95$  indicates that data probably does not show linear dependency so the use of nonlinear model should be preferred (fig. 32 on page 82 – specimen B3 and some others, fig. 48 on page 100 – Retroculated foam, Normal foam).

On the contrary, the dependency of permeability on pressure in fig. 67 on page 118 seems to be linear. But parabolic regression model was chosen.

**Questions:**

- 1) In second paragraph on page 115 you present, considering the calculation of air permeability, linear dependency of flow rate through textile layer on pressure difference (eqn. 2). On page 119 there is presented dependency of pressure difference on linear and quadratic term of flow rate (eqn. 4). There is also correctly mentioned by author that linear term is typical for instance of small velocities. What do you mean, based on waste range of measured cases presented in this work, does the flow rate and then as you deduce the permeability depend on pressure difference more in linear (eqn. 2) or quadratic form (eqn. 4) under conditions considered for seats? Why did you choose the quadratic formula for determination of permeability parameters (page 120)?
- 2) 3D mesh seems to be very convenient material from the point of view of breathability. This material also successfully passed several days of cyclic loading test without any damage. Do you have any information about long time durability when the material is exposed to everyday temperature and humidity change, ultraviolet rays and others? These are condition which is possible to consider in case of seats. What is the cost of 3D mesh in comparison with conventional PU foam?

**Conclusion:**

This thesis brings very interesting and complex view on properties of seats with respect to evaluation of human comfort by means of methods and approaches elaborated for evaluation of textile materials. The large number of performed and evaluated experiments allows to reader to gain robust knowledge and get the guidance on problem. So this is the work which lays down solid foundations for any further research. The author proved ability to use scientific methods, analyze and interpret obtained results. There are presented new experimental methods in this work and materials modified in innovative way. It is a contribution to development of solved problem as illustrated by the fact that student is an author or co-author of 10 articles in international journals including 4 with impact factor and also of 7 articles presented on international conferences. The objectives of the work were met. The comments mentioned above do not detract from the overall quality of this work.

**Therefore I recommend the thesis for presentation in front of respected committee with the aim of receiving the Degree of Ph.D.**

Liberec, 30-th August 2017



doc. Ing. David Cirkl, Ph.D.  
Department of Applied Mechanics  
Faculty of Mechanical Engineering  
Technical University of Liberec