



BIOPOLYMER FOR REDUCTION OF COTTON FLAMMABILITY

Muhammad Sajid Faheem, MS.c.

SUMMARY OF THE THESIS

Title of the thesis: **Biopolymer for Reduction of Cotton Flammability**
Author: **Muhammad Sajid Faheem, M.Sc.**
Field of study: **Textile Technics and Materials Engineering**
Mode of study: **Full time**
Department: **Department of Material Engineering**
Supervisor: **prof. Ing. Jakub Wiener, Ph.D.**

Committee for defence of the dissertation:

Chairman:

prof. Dr. Ing. Zdeněk Kůs FT TUL, Department of Clothing

Vice-chairman:

prof. Ing. Luboš Hes, DrSc., Dr.h.c. FT TUL, Department of Textile Evaluation

doc. Ing. Vladimír Bajzík, Ph.D. FT TUL, Department of Textile Evaluation

doc. Ing. Ladislav Burgert, CSc. University of Pardubice, Faculty of Chemical Technology

doc. Ing. Stanislav Petřík, CSc. (opponent)Cxl TUL, Department of Advanced Materials

Ing. Michal Černý, Ph.D. University of Pardubice, Faculty of Chemical Technology

Ing. Blanka Tomková, Ph.D. FT TUL, Department of Material Engineering

The dissertation is available at the Dean's Office FT TUL.

Liberec 2023

Abstract

Cotton is an extensively utilized natural textile fiber but its applicability is negatively influenced by high flammability due to its cellulosic nature. Cotton ignites very easily with a rapid flame spread and quickly consumes as fuel ensuing perilous fires that can cause huge materials loss and fatal accidents. The desire to improve flame retardant properties of cellulosic textile materials for the reduction of fire hazards has been a major preoccupation over the years for the safety of ultimate consumers under many circumstances.

However, most of the high-performing flame retardants for cellulosic textile products have been banned or limited from industrial/commercial use facing several changes and challenges of health issues and environmental concerns. Due to these considerations, researchers and manufacturers have been deploying their endeavors to find, design, and develop some efficient but more environmentally benign specialty flame retardant finishing materials/products for cellulosic textile substrates to reduce their flame vulnerabilities. Contextually, in recent years, bio-based natural and renewable materials/products, i.e., biopolymers have become of growing interest and gained significant importance because of their environmental friendliness.

The focal intent of the present work was to scrutinize the applications of a biopolymer, i.e., bovine milk casein (bovine milk protein; a phosphoprotein) on cotton fabrics as green and environment-friendly flame retardant finishing material to provide an attractive solution for the valorization of the dairy industry by utilization of its by-product or waste in the improvement of flame retardant performance, char formation, and intumescence effect of cotton fabrics. Casein was applied on cotton fabrics just as it alone and in combination with other environment-friendly materials (such as ammonium polyphosphate and polyvinyl alcohol) for synergistic/hybrid effects in different concentrations through non-hazardous aqueous solvents/solutions and simple industrial applicable textile finishing techniques/methods (such as roller padding, roller coating, and electrospray coating). Physiological comfort, mechanical properties, and washing durability accompanying flame retardancy and thermal properties of cotton fabrics finished with casein and casein-based synergistic/hybrid systems were also perused.

Different kinds of measurements, characterization, and testing techniques were employed on control and finished cotton fabrics to determine, investigate and evaluate the different parameters, features, and properties such as surface properties (surface morphology, surface chemical structure, elemental contents analysis), thermal properties (thermo-oxidative stability, flame retardancy, limiting oxygen index, radiant heat resistance, intumescent system performance), comfort properties (air permeability, water vapor permeability, thermal conductivity, bending rigidity) mechanical properties (tensile performance, tear performance), and durability properties (durability to washing) according to feasible standard test methods. Results were analyzed, interpreted, discussed, and concluded to study and investigate causes with logical reasons for observance of different functional properties. Casein finished cotton fabrics demonstrated, slow flame propagation as also revealed from the image analysis data of burn length and burn area, and enhancement in limiting oxygen index, producing a higher amount of thermally stable char residues. Casein was ascertained to develop flame retardant intumescent systems in combined applications with other synergistic chemicals/compounds. Cotton fabrics indicated stronger sensitization of cellulose decomposition and exhibited higher thermo-oxidative stability properties after treatments with casein macromolecules alone and in combination with other thermally stable and phosphorous-rich flame retardant compounds. As in the case of other flame retardant chemicals finishing, likewise, physiological comfort and mechanical properties of casein finished cotton fabrics were affected depending on the deposited amount of chemicals/finishes as well as governing by application methods. In addition, after-treatments of casein finished cotton fabrics, with certain suitable less toxic and/or environmentally friendly chemical agents pertaining to different crosslinking/binding systems (such as phenols, aldehydes, carboxylic acids, resins, silanes), facilitated the improvement of their durability against washing.

Keywords: Cotton fabric; Flammability; Casein; Flame retardant; Flame retardancy; Char residue; Intumescent

Abstrakt

Bavlna je hojně využívané přírodní textilní vlákno, ale její použitelnost je negativně ovlivněna vysokou hořlavostí díky obsahu celulózy. Bavlna se velmi snadno vzněcuje, plamen se rychle šíří a rychle se mění v popel. Je příčinou nebezpečných požárů, které mohou způsobit obrovské materiální škody a smrtelné nehody. Snaha zlepšit vlastnosti celulózových textilních materiálů zpomalující hoření za účelem snížení nebezpečí požáru byla v průběhu let hlavním zájmem řešení nehořlavých úprav zajišťujících bezpečnost spotřebitelů.

Nicméně, většina vysoce účinných zpomalovačů hoření pro celulózové textilní výrobky byla zakázána nebo omezena pro průmyslové/komerční použití, pro svoji zdravotní závadnost a negativní vliv na životní prostředí. Výzkumní pracovníci a výrobci se tedy snaží najít, navrhnout a vyvinout některé účinné, ale k životnímu prostředí šetrnější speciální materiály/produkty zpomalující hoření celulózových textilních substrátů. V souvislosti s tím se v posledních letech zkoumají přírodní materiály/produkty na biologické bázi, tj. biopolymery.

Hlavním záměrem této práce bylo prozkoumat aplikace speciálního biopolymeru, tj. kaseinu z hovězího mléka (bílkovina z hovězího mléka; fosfoprotein) na bavlněné tkaniny. Kasein je ekologický přijatelný materiál zpomalující hoření. Umožňuje atraktivní zhodnocení vedlejšího produktu/odpadu mlékárenského průmyslu ke zpomalování hoření, tvorby zuhelnatělého zbytku a intumescenčního efektu na bavlněných tkaninách. Bylo zkoumáno ovlivnění fyziologického komfortu, mechanických vlastností, trvanlivosti při praní a tepelných vlastností kaseinem upravených bavlněných tkanin. Kasein byl aplikován na bavlněné tkaniny samostatně a v kombinaci s dalšími materiály šetrnými k životnímu prostředí (jako je polyfosfát amonný a polyvinylalkohol). Byla použita bezpečná vodná rozpouštědla/roztoky a jednoduché, průmyslové textilní zušlechťovací techniky/metody (jako je válečkové nanášení, zátěry a elektrosprejová úprava). Fyziologický komfort, mechanické vlastnosti a trvanlivost při praní doprovázející zpomalování hoření a tepelné vlastnosti bavlněných tkanin s kaseinovou a synergické/hybridní systémy na bázi kaseinu úpravou byli také stíháni.

U kontrolních a upravených bavlněných tkanin byly použity různé druhy měření, charakterizace a testovacích technik pro stanovení, zkoumání a hodnocení různých parametrů a vlastností, jako jsou povrchová struktura (morfologie povrchu, chemická struktura povrchu, analýza obsahu prvků), tepelné vlastnosti (termooxidační stabilita, zpomalení hoření, limitní kyslíkové číslo, odolnost proti sálavému teplu, intenzita bobtnání), vlastnosti související s komfortem (propustnost vzduchu, propustnost vodní páry, tepelná vodivost, tuhost v ohybu) mechanické vlastnosti (tažnost, odolnost proti protržení) a trvanlivosti úprav (odolnost v opakovaném praní) podle standardních zkušebních metod. Výstupní data byla analyzována, interpretována, diskutována a komplexně zhodnocena. Byly zkoumány příčiny a logické důvody pro docílení různých funkčních vlastností. Bavlněné tkaniny upravené kaseinem prokázaly pomalé šíření plamene (jak bylo určeno z dat analýzy obrazu délky hoření a oblasti hoření), zlepšení limitního kyslíkového čísla a produkci vyššího množství tepelně stabilních zuhelnatělých zbytků. Bylo zjištěno, že kasein vyvíjí intumescenční systémy zpomalující hoření v kombinovaných aplikacích s jinými synergickými chemikáliemi/sloučeninami. Bavlněné tkaniny vykazovaly vyšší odolnost proti tepelnému rozkladu a vyšší termooxidační stabilitu po ošetření samotnými kaseinovými makromolekulami a v kombinaci s jinými tepelně stabilními a na fosfor bohatými samozhášecími sloučeninami. Stejně jako v případě jiných chemických úprav zpomalujících hoření byl ovlivněn fyziologický komfort a mechanické vlastnosti bavlněných tkanin s úpravou kaseinem. Míra ovlivnění závisela na naneseném množství chemikálií/apretur a také na aplikačních metodách. Kromě toho následná úprava kasein obsahujících bavlněných tkanin s vhodnými méně toxickými a/nebo ekologicky šetrnými síťovacími/vazebnými systémy (jako jsou aldehydy, karboxylové kyseliny, pryskyřice, silany), vedla ke zlepšení odolnosti v praní.

Klíčová slova: Bavlněné textilie; Hořlavost; Kasein; Zpomalovače hoření; Zpomalení hoření; Zuhelnatělé zbytky; Intumescenční vrstvy

Table of contents

Abstract	ii
Abstrakt	iii
Table of contents	iv
1	Introduction1
2	Purpose and the aims of the thesis2
3	Overview of the current state of the problem3
4	Methods used, studied materials4
4.1	Materials4
4.2	Methodology.....5
4.2.1	Preparation of casein solution.....5
4.2.2	Preparation of ammonium polyphosphate solution6
4.2.3	Preparation of polyvinyl alcohol solution7
4.2.4	Preparation of crosslinking chemicals solution.....7
4.2.5	Sample preparation of casein treated cotton fabrics8
4.2.6	Sample preparation of alkaline and acidic casein solutions coated cotton fabrics8
4.2.7	Sample preparation of casein in combination with ammonium polyphosphate bilayer coated cotton fabrics9
4.2.8	Sample preparation of casein and polyvinyl alcohol based bicomponent composite nanoparticles coated cotton fabrics10
4.2.9	Sample preparation for crosslinking of casein with cotton fabrics.....11
4.2.10	Characterization and testing.....11
	<i>Surface chemical structure</i>12
	<i>Surface morphology</i>12
	<i>Elemental contents</i>12
	<i>Thermo-oxidative stability</i>12
	<i>Flammability / flame retardancy</i>13
	<i>Limiting oxygen index</i>13
	<i>Radiant heat resistance</i>13
	<i>Thermal performance of intumescent char residues</i>13
	<i>Air permeability</i>13
	<i>Water vapor permeability</i>13
	<i>Thermal conductivity</i>13
	<i>Stiffness / Bending rigidity</i>13
	<i>Tensile properties</i>14
	<i>Tear properties</i>14
	<i>Washing durability</i>14
5	Summary of the results achieved14
5.1	Flame retardant performance and char formation properties of casein treated cotton fabrics14
5.1.1	Surface chemical structure14
5.1.2	Surface morphology.....14
5.1.3	Thermo-oxidative stability15

5.1.4	Flame retardancy	16
5.1.5	Radiant heat resistance	18
5.1.6	Physiological comfort and mechanical properties.....	19
5.2	Flame retardant behavior and inherent intumescent phenomenon of alkaline and acidic casein solutions coated cotton fabrics	22
5.2.1	Surface chemical structure	22
5.2.2	Surface morphology.....	23
5.2.3	Thermo-oxidative stability	23
5.2.4	Flame retardancy	25
5.2.5	Radiant heat resistance	28
5.3	Intumescent flame retardant system based on casein in combination with ammonium polyphosphate	29
5.3.1	Surface chemical structure	30
5.3.2	Surface morphology.....	30
5.3.3	Thermo-oxidative stability	31
5.3.4	Flame retardancy	33
5.3.5	Radiant heat resistance	37
5.4	Flame retardant and intumescent char formation potentials of casein and polyvinyl alcohol based bicomponent composite nanoparticles coated cotton fabrics	38
5.4.1	Surface chemical structure	38
5.4.2	Surface morphology.....	38
5.4.3	Thermo-oxidative stability	39
5.4.4	Flame retardancy	40
5.4.5	Radiant heat resistance	43
5.4.6	Physiological comfort and mechanical properties.....	44
5.5	Washing durability and crosslinking of casein with cotton fabrics.....	46
6	Evaluation of results and new findings	49
7	References	51
8	List of publications by the author	57
9	Curriculum Vitae.....	59
10	Recommendation of Supervisor	61
11	Reviews of the Opponents	62

1 Introduction

Textiles play an important role in everyday life. Like most polymeric materials such as foams and plastics [1], textiles are extremely vulnerable to flame and fire exposures. The flammability of textile materials/products (i.e., fibers, yarns, and fabrics) signifies an area of the safety issue, which evinces that textiles are the first thing to be ignited even by small flames (such as matchsticks, cigarettes, candles, etc.) thus resulting in the most common fire [2]. As far as the burning of textiles is concerned, one main drawback refers to their primitive matter. Such as they are mostly based on organic polymers, which are usually flammable contrarily if not inherently flame retarded [3]. Flame and/or fire retardants (i.e., additives/chemicals/finishes) are commonly applied to different kinds of materials to make them non-flammable or self-extinguishing, as the principle of flame/fire retardants (FRs) is to reduce their propensity to flame spread and further to ignite/burn when subjected to a heating source or open flame [4]. Therefore a flame retardant fabric does not stimulate to propagate the flame, although it may burn and/or char when it is exposed to any form of heat source. Char formation confines the amount of flammable volatiles and gases acting as a diffusion barrier and reduces heat transmission into textile material providing a thermally insulating layer at the surface. Among all textiles, cellulosic fibers are most susceptible to flame and/or fire. When ignited they undergo rapid thermal degradation, forming combustible volatile gaseous compounds that further get involved to propagate fire, and leaving no char residues (almost negligible amount) behind except traces of ash [5]. Production of flame-retardant cellulose-based textiles has always been the most challenging task. Providentially cellulose has a chemical composition that makes it easily susceptible to conjoint flame retardant treatments. Flame retardant treatments are generally applied to textile materials through chemical finishing and it is also the most commonly used method to produce flame-retardant cotton fabrics as well.

Cotton is a natural cellulosic fiber and one of the most important natural biopolymers in the world. It is commonly used in wide application areas indeed due to its availability in large quantities and plentiful diverse advantages such as good mechanical properties, hydrophilicity, physiological comfort, biodegradability, absence of static charge problems, etc. However thermal properties such as high flammability, ease of ignition, low thermal stability, and quick burning/combustion of cotton textiles restricted many of their specific applications in transportation, automotive, protective garments, military, home/furniture upholstery, apparel, bed/nightwear, etc. When cotton fabrics are exposed to any kind of heating source, it starts to degrade and undergoes thermal decomposition. More precisely, degradation phenomena usually involve the dehydration of glycosyl units to produce a thermally stable carbonaceous structure (usually called char) and/or depolymerization of such units to release volatile species/gases able to further fuel the process [6]. Hence, one possible strategy to hinder the degradation process is to assist dehydration rather than depolymerization. This could be attained by using species/compounds efficient enough to interfere with the degradation process. However, it is generally expected that an effective flame retardant controls pyrolysis by instigating cellulose, to carbonize through dehydration, at temperatures below 300°C. Preferably an ideal flame retardant system, for cellulose chars generation, prevents afterglow and minimizes the release of toxic gases and smoke. Alternatively, intumescent flame retardant systems also provide some potential promises for flame and heat protection [7].

Most of the existing successful commercial flame retardant treatments, formulations/finishes, and chemicals/additives for textiles are primeval and old over fifty years and derived from chemistry developed in the golden period of 1950-1980 [8]. Currently, the most common flame retardants that are being used for cotton and other cellulosic textile materials/products are mainly halogens, phosphorous, and nitrogen elements based compounds [9]. As a research and development results in the last fifty years, most of the high performing halogen-based (release toxic fumes and harmful/corrosive gases on thermal degradation) and phosphorous-based (release formaldehyde during manufacturing and also on heating at application and end-use stages) flame retardants for cellulosic fabrics have been banned or limited from industrial and commercial use. They have also been facing several changes and challenges and suspecting to evoke some specific health and environmental concerns as they have already proven to be bioaccumulative, persistent, toxic and/or carcinogenic for animals and humans [10, 11]. According to these perspectives, the use of bio-based natural and renewable materials (i.e., biopolymers) including biowastes has been the focus of the scientific research community towards all environmental preservation and sustainability of resources. In very recent times, biopolymer-based materials have attracted considerable attention and exploded interest in the field of flame retardancy because of their low environmental impact and toxicity [12, 13]. Biopolymers such as protein fractions derived from animals have shown unexpected flame retardant/suppressant potentials when deposited on selected cellulosic and synthetic textile substrates like cotton, polyester, or cotton-polyester blends [14]. The use of bovine milk-derived casein protein as a flame retardant is a significant advantage since it can be considered as a waste or co-product obtained from the milk industry during the production of skim milk and cheese. Casein is a major fraction (80%) of bovine milk proteins. It is actually a family of proteins synthesized in the mammary glands [15]. Perhaps the most widely studied and investigated protein due to its latent bio- and techno-functional properties. Casein is a

phosphoprotein (i.e., polyamino acids bearing several phosphate groups in its micellar structure) and exists in milk in form of large self-assembled colloidal particles, known as “micelles”. It is a globular protein with an amphiphilic structure and usually composed of α_{S1} -, α_{S2} -, β -, κ - casein, according to the nomenclature developed for bovine milk caseins [16]. Flame retardant effectiveness or conformance of casein (a natural green, eco-friendly, and renewable biomacromolecule) can be attributable to its chemical composition. As, cellulosic fibers such as cotton can suitably be flame retarded with phosphorus-based flame retardants, owing to the presence of the hydroxyl groups. Furthermore, the phosphorus and phosphorous-nitrogen based compounds are regarded as effective flame retardants for cotton fabrics [17, 18]. They can dehydrate cellulose during the thermal decomposition process rather than its depolymerization and enhance the formation of a thermally stable carbonaceous structure (char) instead of the production of combustible volatile products. Additionally, the flame retardant efficiency of phosphorous-based compounds also improves due to the synergistic effect of nitrogen elements [19, 20].

2 Purpose and the aims of the thesis

The urge to improve flame retardant properties of cellulosic textile materials for the reduction of fire hazards has been a major concern over the years and most of the efforts have been purported primarily to develop efficient and environmentally benign flame retardant finishing for cotton fabrics to reduce their flame vulnerabilities. In this regard, the research and development emphasizing bio-based materials/polymers, to study and investigate their flame retardant properties for textiles, is relatively a novel thought and also an emerging potential field of the recent decade. In this context, the current research work idea/plan was postulated and presented, overall aiming to assess different hidden and inherent key techno-functional features of bovine milk casein protein (owing to its chemical composition/structure) for flame retardancy, char formation, and intumescence effect for cotton fabrics, furthermore, its impact on basic essential and desired properties of cotton fabrics. This was expected to be done by exploiting casein application on cotton fabrics just as it alone and in combination with other environmentally friendly materials for synergistic/hybrid effects. In particular, the exploration of its application on cotton fabrics through non-hazardous solvents/solutions, i.e., aqueous solutions by using simple, time-saving, and industrially applicable techniques/methods. As traditional potential flame retardant treatments may cause deleterious effects on the physiological comfort as well as on the mechanical properties of textile fabrics. Therefore simultaneously the determination of physiological comfort, mechanical performance, and washing durability accompanying flame retardancy and thermal properties of casein finished cotton fabrics was also intended to contemplate in this research work.

Comprehending the canvass as discussed in the previous section, the overall originated major aims and objectives of this research work study are as follows:

- ***Flame retardant performance and char formation properties of casein for cotton fabrics***
 - Preparation of casein aqueous solutions of different possible concentrations revealing its swelling and solubility limits as well as consistent and stable solution-forming properties as a prerequisite, and their application on cotton fabrics.
 - Proving commonly used parameters/conditions of the textile fabric finishing process, to observe ease and compliance of casein solutions' application through roller padding method, as well as, to attain an adequate amount of casein add-on/uptake on treated cotton fabrics.
 - Conforming to its effectiveness, for flame retardant and char formation properties of casein treated cotton fabrics.
 - Examination of physiological comfort and mechanical properties accompanying flame retardancy and thermal properties of casein treated cotton fabrics.
- ***Comparative evaluation of flame retardant behavior and inherent intumescent phenomenon of alkaline and acidic casein solution coatings for cotton fabrics***
 - Attempting the dissolution of casein in water at alkaline and acidic pH conditions to prepare solutions of different possible concentrations revealing its swelling and solubility limits as well as consistent and stable solution-forming properties.
 - Application of alkaline and acidic casein solutions on cotton fabrics through roller/bar coating method, as well as, essaying to deposit higher amounts of casein (add-on/weight gain) on coated cotton fabrics.
 - Evaluation of the comparative performance of flame retardant and char formation properties in conjunction with an inherent intumescent phenomenon of alkaline and acidic casein solutions coated cotton fabrics.
- ***Intumescent flame retardant system based on casein in combination with ammonium polyphosphate for cotton fabrics***

- Developing an efficient and effective flame retardant intumescent system for cotton fabrics using halogen-free and environment-friendly resources; casein as a biopolymer-based carbonization agent and ammonium polyphosphate as an acid-releasing agent.
- Building up the polyelectrolyte bilayer assemblies/coatings of casein and ammonium polyphosphate on cotton fabrics from aqueous solutions by depositing and coupling positively charged casein (as polycations) with negatively charged ammonium polyphosphate (as polyanions) by using roller/bar coating method.
- Examination of the effect of different concentrations of casein and ammonium polyphosphate in bilayer assemblies/coatings for the changes in thermal properties and flame retardant behavior of cotton fabrics.
- Exploration of intumescent char layers formation phenomenon controlling the thermal transmission and release of cellulose's gaseous products and conforming to the effectiveness of the developed intumescent flame retardant system.
- ***Flame retardant and intumescent char formation potentials of casein and polyvinyl alcohol based bicomponent composite nanoparticles for cotton fabrics***
 - Endeavoring the processability of casein to fabricate submicron size droplets/particles by utilization of the electrospraying technique starting with aqueous solutions.
 - Deposition of electrosprayed casein/polyvinyl-alcohol bicomponent composite nanoparticles on the surface of cotton fabrics as very fine and uniform layers/coatings, in order to develop an ecologically acceptable flame retardant and intumescent char forming system.
 - Approximation of the effect of different composition casein/polyvinyl-alcohol nanoparticles' coatings for the changes in thermal properties and flame retardant behavior of cotton fabrics.
 - Examination of physiological comfort and mechanical properties accompanying flame retardancy and thermal properties of cotton fabrics electrospray coated with casein/polyvinyl-alcohol nanoparticles.
- ***Washing durability of casein treated cotton fabrics***
 - Evaluation of durability against washing/laundry of a proffered biopolymer-based flame retardant material, i.e., casein protein.
 - Improving the washing durability of casein treated cotton fabrics by suitable chemical crosslinking/binding systems.
 - Comparing the chemical crosslinking systems based on glutaraldehyde (a dialdehyde), citric acid (a polycarboxylic acid), tannic acid (a polyphenol), Texapret LF (a resin), and tetraethoxysilane (a silane) for washing durability of casein treated cotton fabrics.

3 Overview of the current state of the problem

Nowadays, the major and most important highlighted issue and challenge throughout the textile and/or chemical finishing industry is the ever-increasing influence of environmental and ecological factors and in general associated present concerns leveled at the use of flame retardants. Flame retardancy future is obstructed significantly by the eco-toxicological and environmental considerations, the flame retardants used, and the toxic nature of products released on combustion of textiles.

At present, a major part of commercially available potent flame retardants are petrochemical-based organic compounds (e.g., organo-halogenated, organo-phosphorous, organo-nitrogen compounds). Phosphorus-based flame retardant counterparts seem real as a suitable, potential, and efficient alternative to halogen-based compounds for different types of fibers/fabrics [21]. Though, it is not overall a general case that all phosphorus-based flame retardants are nontoxic, as the development of new flame retardants based on phosphorus compounds has revealed that they have lower toxicity profiles as compared to that halogen-based counterparts [22]. However, considering the pros and cons, and according to very strict proclamations/directives concerning the chemistry of flame retardants used, a large number of flame retardant compounds including some of the currently used halogenated and phosphorous-based compounds received a bad press. They have been limited, are no longer produced, and have been removed from the market or even banned. They are on special lists of national and/or international environmental concerns committees, as they are suspected to stimulate specific health and environmental issues. Because they release toxic products (furans, dioxins, ammonia, formaldehyde, other volatile organic compounds, etc.) during; manufacturing, application to textiles, upon combustion of textiles, etc. [23]. They also have certainly divulged high toxicity for both animals and humans as they do not easily break down, can build up in animals and humans over time (bioaccumulation), and can remain persistent in the environment for years [24].

However, there are many concerns about the use of flame retardants in all kinds of textiles. Exposures (namely pathways exposure and route exposure) may occur at numerous points in the whole life-cycle of a

flame retardant typified by; occupational exposure (during manufacturing/industrial operations), consumer exposure (during end use), and public and environment exposure to releases (during product disposal or from manufacturing/industrial facilities). In general, ideal flame retardant chemicals and finishes should not be persistent, bioaccumulative, and/or toxic to humans, animals, and/or ecosystems. They should not cause adverse health effects to ultimate consumers and/or adversely affect the overall environment such as air, water, soil, etc. Therefore, it stimulated both the academic and industrial scientific communities to endow continuous efforts towards research and development in order to find out worthy alternatives and counterparts to traditional flame retardants. In the last few years, extensive consideration and attention have been concentrated on biomass-based (bio-based, i.e., biopolymers; biomacromolecules) natural products due to their renewable resources and environmental friendliness.

Biopolymers generally refer to bio-based compounds that can be obtained and/or derived from biomass. Biomass exists on earth in the form of biological matter including plants, animals, and microorganisms, which represents about 560 billion tons of carbon apart from bacteria. Vassilev et al. analyzed and presented an overview particularly related to the chemical composition of biomass relying on the general organization of biomass into groups, subgroups, varieties, and species [25]. Although depending on groups, this composition is quite different and very variable but they were able to identify the most abundant elements such as; C, H, N, Ca, K, Si, Mg, Al, S, Fe, P, Cl, Na, Mn, and Ti, in decreasing order. It is commendable to mention that some of these elements are commonly known to possess a flame-retardant effect.

Up to almost ten years ago, utilization of these biopolymers/biomacromolecules was absolutely allocated for other application fields and have been used as edible films, food emulsifiers, adhesives, papermaking, printing, leather finishing systems, as well as, for the design of biosensors and environmental monitoring systems. In very recent years, continuous efforts have been expended by researchers, pursuing and looking for novel cost-effective, and environmentally sustainable flame retardants for textiles based on the use of biomacromolecules due to enhanced awareness of environmental protection. In this connection, biopolymers, in particular, animal-derived natural products, i.e., proteins such as casein, whey, hydrophobins, deoxyribonucleic acid, etc., presented a potentially innovative strategy and worthy alternatives to traditional chemicals/finishes and approaches for improving the textile materials' thermal stability and flame retardancy. Despite this, some issues relating to the durability of these treatments are still unresolved [12, 13]. Actually, the chemical structure of some of these natural products evinces the presence of nitrogen, phosphorus, sulfur, etc., which can impart flame-retardant features to different types of fibers and fabrics.

4 Methods used, studied materials

4.1 Materials

The pretreated, standard bleached, 100% cotton woven fabric was used as a substrate. The fabric was purchased from Licolor, a.s., Czech Republic. The weave of the fabric was plain with a well-balanced construction. The photographs of cotton fabric are shown in Figure 1. The preliminary fabric characterization tests were performed according to the standard test methods. The investigated and evaluated different specifications of fabric are given in Table 1.

Table 1. Technical specifications of cotton fabric used for research work

Fabric specification	Value
Warp yarns composition	100 % cotton
Weft yarns composition	100 % cotton
Weave structure/pattern	Plain 1/1
Areal Density (g/m ²)	145
Warp yarns count (tex)	29.5
Weft yarns count (tex)	29.5
Ends (warp yarns) / cm	26
Picks (weft yarns) / cm	22
Fabric thickness (mm)	0.33
Fabric volume porosity (%)	72
Tegewa rating of fabric	9
Fabric absorbency (s)	3
pH of fabric	7.1



(a) Digital photograph

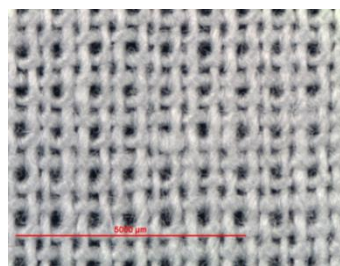

(b) Digital Photomicrograph

Figure 1. Photographs of cotton fabric used for research work

The details of the chemicals' specifications and sources are given in Table 2. All these chemicals were used as received without any kind of further purification.

Table 2. List of chemicals used for research work

Chemical	Specifications	Source
Bovine milk casein	Purified powder, composition (g/l) of: α -s ₁ (~12-15), α -s ₂ (~3-4), β (~9-11) and κ (~2-4), technical grade	Sigma Aldrich Czech Republic
Ammonium polyphosphate	Fine granular powder, crystal phase II, n>1000, technical grade	Aako Chemicals Netherland
Polyvinyl alcohol	Crystalline solid, average M _w . 9000-1000, 80% hydrolyzed, technical grade	Sigma Aldrich Czech Republic
Glutaraldehyde	Aqueous solution, 50%, reagent grade	Sigma Aldrich Czech Republic
Citric acid	Anhydrous, granular powder, ≥99%, reagent grade	Sigma Aldrich Czech Republic
Tannic acid	Powder, specific form of tannin, ≥99%, reagent grade	Sigma Aldrich Czech Republic
Texapret LF	Liquid, nonionic, modified dimethylol-dihydroxy-ethylene-urea based resin, commercial grade	Inotex Czech Republic
Tetraethoxy silane	Liquid, 98%, reagent grade	Sigma Aldrich Czech Republic
Sodium hydroxide	Pearls, ≥99%, reagent grade	Lach-Ner Czech Republic
Hydrochloric acid	Aqueous solution, 35%, reagent grade	Lach-Ner Czech Republic
Acetic acid	Liquid, 98%, reagent grade	Lach-Ner Czech Republic
Ethyl alcohol	Liquid, 96%, reagent grade	Lach-Ner Czech Republic
Trisodium citrate	Anhydrous, granular powder, ≥98%, reagent grade	Lach-Ner Czech Republic
Magnesium chloride	Hexahydrate, granular powder, ≥99%, reagent grade	Lach-Ner Czech Republic

4.2 Methodology

The solutions of different chemicals, used in this research work, were prepared in the distilled water complying with the different specified time, temperature, and pH conditions. These different conditions were finalized after reviewing the literature and conducting different trials to find out the best parameters that confirmed the solubility of these chemicals and materials in water to form homogeneous aqueous solutions/colloids/emulsions/suspensions. Although the materials used, such as casein and polyvinyl alcohol are also soluble in their other respective solvents. Nonetheless, all the solutions were prepared in water due to addressing ecologically-safe systems.

4.2.1 Preparation of casein solution

The aqueous solutions of casein (CAS) were prepared, under alkaline condition, at six different concentrations such as 5, 10, 15, 20, 25, 30% w/v (i.e., 50, 100, 150, 200, 250, 300 g/l). At first, the calculated quantity of casein powder was added to distilled water under continuous magnetic stirring/agitation (300 rpm) at room temperature for 10 min. It contributed to loosening the molecular structure of casein thus allowing interactions with both the water and further the casein molecules. Then,

the temperature of the mixture was raised slowly and it was heated to 80°C in a thermostatic bath. Meanwhile, the pH was adjusted to 9 with a dropwise addition of 1M NaOH, under continuous magnetic stirring (600 rpm). The process was later stopped when the casein was completely dissolved in water. Finally, the solutions were cooled down to almost 30°C before applying to cotton fabrics. The whole process for casein solution preparation, under alkaline conditions, is explained in the process profile as shown in Figure 2.

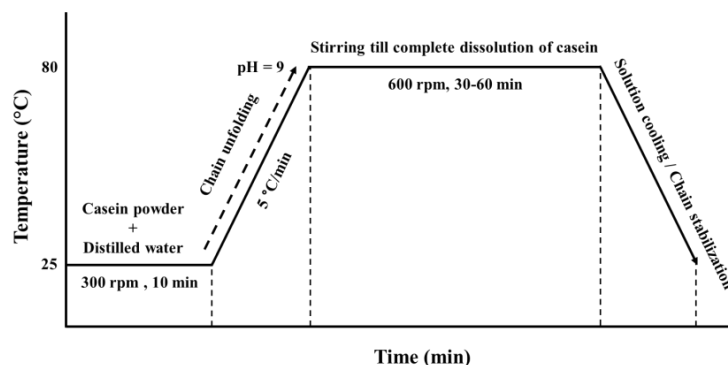

Figure 2. Process profile for casein solution preparation in alkaline condition

The aqueous solutions of casein (CAS) were also prepared, under acidic condition, at three different concentrations such as 5, 10, 15% w/v (i.e., 50, 100, 150 g/l). At first, the calculated quantity of casein powder was added to distilled water under continuous magnetic stirring/agitation (300 rpm) at room temperature for 10 min. It contributed to loosening the molecular structure of casein thus allowing interactions with both the water and further the casein molecules. Then, the temperature of the mixture was raised slowly and it was heated to 80°C in a thermostatic bath. Meanwhile, the pH was adjusted to 3 with a dropwise addition of 1M HCl, under continuous magnetic stirring (600 rpm). The process was later stopped when the casein was completely dissolved in water. Finally, the solutions were cooled down to almost 30°C before applying to cotton fabrics. The whole process for casein solution preparation, under acidic conditions, is explained in the process profile as shown in Figure 3.

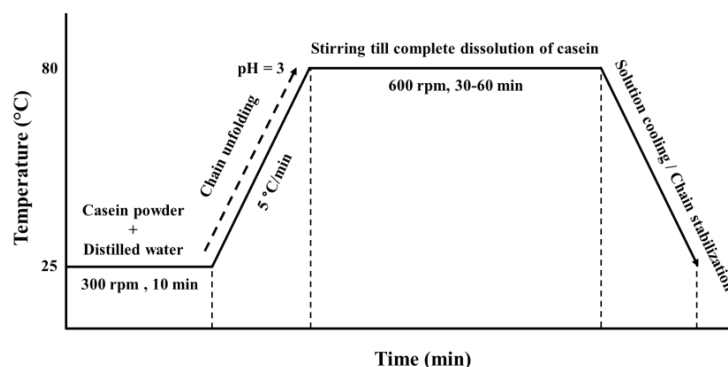

Figure 3. Process profile for casein solution preparation in acidic condition

4.2.2 Preparation of ammonium polyphosphate solution

The aqueous solutions of ammonium polyphosphate (APP) were prepared, under alkaline conditions, at three different concentrations such as 2.5, 5, 7.5% w/v (i.e., 25, 50, 75 g/l). At first, the calculated quantity of APP powder was added to distilled water under continuous magnetic stirring/agitation (300 rpm) at room temperature for 10 min. It contributed to loosening the molecular structure of the APP thus allowing interactions with both the water and further the APP molecules. Then, the solution preparation process was continued at room temperature. Meanwhile, the pH of the mixture was adjusted to 11 with a dropwise addition of 1M NaOH, under continuous magnetic stirring (600 rpm). The process was later stopped when the APP was completely dissolved in water at room temperature. The whole process for APP solution preparation is explained in the process profile as shown in Figure 4.

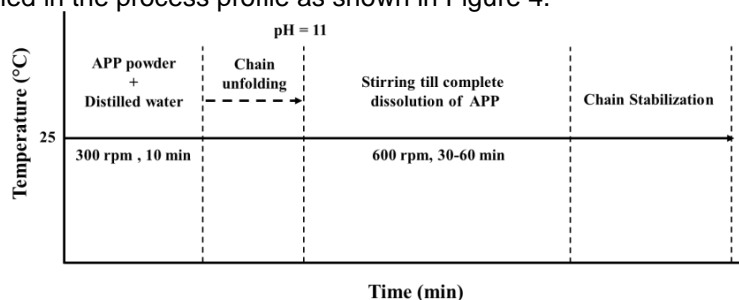

Figure 4. Process profile for ammonium polyphosphate solution preparation

4.2.3 Preparation of polyvinyl alcohol solution

The aqueous solution of polyvinyl alcohol (PVA) was prepared at 10% w/v (i.e., 100 g/l) concentration. At first, the calculated quantity of PVA granules was added to distilled water under continuous magnetic stirring/agitation (300 rpm) at room temperature for ~24 h. It contributed to loosening the molecular structure of PVA thus allowing interactions with both the water and further the PVA molecules. Then, the temperature of the mixture was raised slowly and it was heated to 50°C under continuous magnetic stirring (600 rpm). The process was later stopped when the PVA was completely dissolved in water. Finally, the solutions were cooled down to room temperature. The whole process for PVA solution preparation is explained in the process profile as shown in Figure 5.

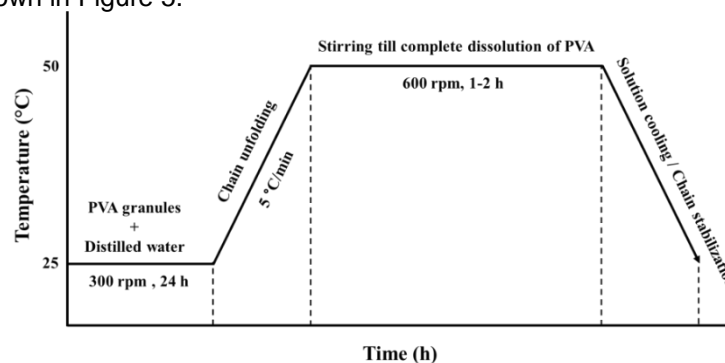

Figure 5. Process profile for polyvinyl alcohol solution preparation

4.2.4 Preparation of crosslinking chemicals solution

The solutions of crosslinking/binding chemical agents belonging to different chemical classes such as; dialdehydes, polycarboxylic acids, polyphenols, resins, silanes, were prepared separately at the same defined concentration of 5% w/v (i.e., 50 g/l). All these solutions were prepared in distilled water at the suitable and applicable conditions of pH, catalyst, time, and temperature as follows.

- **Glutaraldehyde solution preparation:** At first, the calculated quantity of glutaraldehyde solution was added to distilled water under continuous magnetic stirring/agitation (200 rpm) at room temperature. After that, the calculated quantity of magnesium chloride (10 g/l) was added as a catalyst. Then, the solution preparation process was continued at room temperature. Meanwhile, the pH of the mixture was adjusted to 5.0-5.5 with a dropwise addition of acetic acid solution. Thenceforth, the stirring (400 rpm) was continued for 5 min to mix all the ingredients appropriately. The process was later stopped when the homogeneous solution was achieved.
- **Citric acid solution preparation:** At first, the calculated quantity of citric acid powder was added to distilled water under continuous magnetic stirring/agitation (200 rpm) at room temperature. After that, the calculated quantity of trisodium citrate (15 g/l) was added as a catalyst. Then, the solution preparation process was continued at room temperature. Meanwhile, the pH of the mixture was adjusted to 3.5-4.0 with a dropwise addition of sodium hydroxide solution. Thenceforth, the stirring (400 rpm) was continued for 5 min to mix all the ingredients adequately. The process was later stopped when a homogeneous solution was obtained.
- **Tannic acid solution preparation:** At first, the calculated quantity of tannic acid powder was added to distilled water under continuous magnetic stirring/agitation (200 rpm) at room temperature. Then, the solution preparation process was continued at room temperature. Meanwhile, the pH of the mixture was adjusted to 5.0-5.5 with a dropwise addition of sodium hydroxide solution. Thenceforth, the stirring (400 rpm) was continued for 5 min to mix all the ingredients precisely. The process was later stopped when a homogeneous solution was attained.
- **Texapret LF resin solution preparation:** At first, the calculated quantity of Texapret LF resin (modified dimethylol-dihydroxy-ethylene-urea (DMDHEU) based resin) was added to distilled water, under continuous magnetic stirring/agitation (200 rpm) at room temperature. After that, the calculated quantity of magnesium chloride (10 g/l) was added as a catalyst. Then, the solution preparation process was continued at room temperature. Meanwhile, the pH of the mixture was adjusted to 4.5-5.0 with a dropwise addition of acetic acid solution. Thenceforth, the stirring (400 rpm) was continued for 5 min to mix all the ingredients properly. The process was later stopped when a homogeneous solution was gained.
- **Tetraethoxysilane solution preparation:** The silica phase (silica sol) was synthesized by a sol-gel technique using tetraethyl orthosilicate (tetraethoxysilane; TEOS) as a silicon alkoxide precursor. The pure silica sol was prepared via acidic hydrolysis of TEOS. At first, the calculated quantity of ethanol (25 g/l) was added to distilled water, under continuous magnetic stirring/agitation (200 rpm) at room temperature. After that, the calculated quantity of TEOS was added in parts. Then, the solution preparation process was continued at room temperature. Meanwhile, the pH of the mixture was adjusted to 4.5-5.0 with a dropwise addition of acetic acid solution. Thenceforth, the stirring (400 rpm)

was continued for 60 min to mix all the ingredients perfectly and to hydrolyze the TEOS sufficiently. The process was later stopped when a homogeneous and clear solution was acquired.

The prepared aqueous solutions of chemicals were applied on cotton fabric, to develop the final samples, by using different industrially applicable methods. These methods are depicted in the flow chart diagram as shown in Figure 6 and explained in the following sections. The rationale for using and switching the methods step by step was to attain the intended aims and objectives.

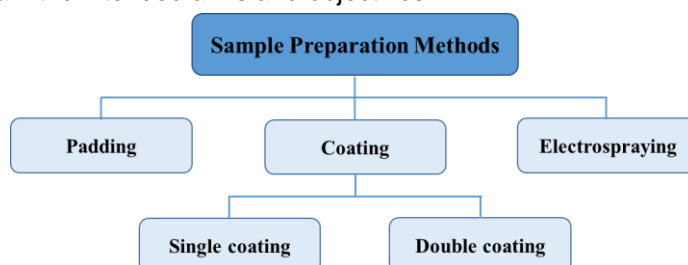

Figure 6. Sample preparation methods

4.2.5 Sample preparation of casein treated cotton fabrics

The different concentrations of casein solutions were applied on cotton fabric (CF) by a padding method as demonstrated in Figure 7 using the lab-scale padding mangle/machine (two bowl/roller vertical padding unit) in $30\pm 2\%$ relative humidity $30\pm 2^\circ\text{C}$ temperature atmosphere.

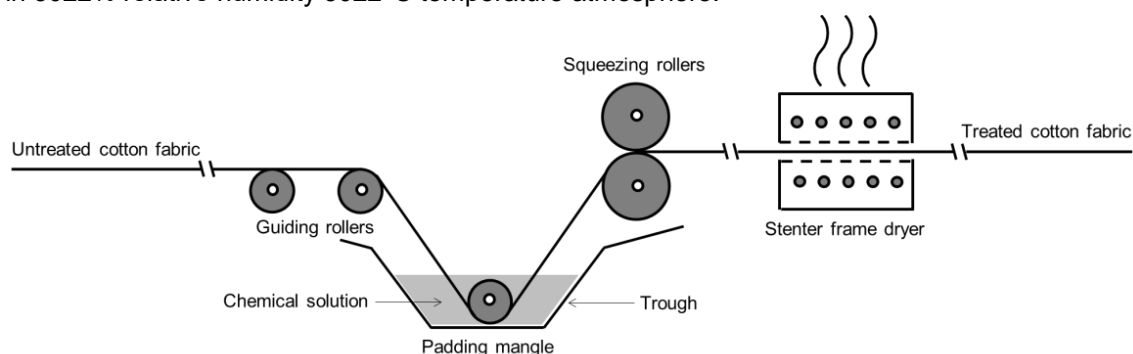

Figure 7. Schematic illustration of sample preparation process through padding method

First, the cotton fabric samples were cut up according to the dimensions of the padding/squeezing rollers. Then, the fabric sample was immersed in the padding mangle/trough containing a finishing solution, i.e., casein solution. Simultaneously, the solution-impregnated fabric sample was squeezed while passing through padding rollers, adjusting the pressure and speed to render 80% wet pick up of the solution on the weight of the fabric. The casein solution padded fabric sample was then placed over a pin frame (stenter frame) in open-width stretched form to avoid any unevenness and dried at 100°C in the lab-scale hot air dryer (stenter frame dryer) for uniform drying. The process was repeated to produce the replicas of treated cotton fabrics for each casein solution respectively, according to the defined experimentation as stated in Table 3. Then, the total dry solid uptake (add-on/weight-gain) for casein treated fabric samples was calculated according to gravimetric principle from the weight of fabric samples by using Equation 1:

$$\text{Add-on (wt. \%)} = \frac{w_f - w_i}{w_i} \times 100 \quad (1)$$

where ' w_i ' is the weight of the cotton fabric sample before impregnation/coating and ' w_f ' is the weight of the cotton fabric sample after impregnation/coating and the subsequent drying.

Table 3. Details of casein treated cotton fabrics

Sample ID	CF_5% casein	CF_10% casein	CF_15% casein	CF_20% casein	CF_25% casein	CF_30% casein
Casein solution concentration	5%	10%	15%	20%	25%	30%

4.2.6 Sample preparation of alkaline and acidic casein solutions coated cotton fabrics

The single coatings (single-/mono- layer coatings) of different concentrations of casein solutions (prepared at alkaline and acidic pH conditions) were applied on cotton fabric (CF) by a coating method as demonstrated in Figure 8 using the lab-scale bar/roller coating unit in $30\pm 2\%$ relative humidity $30\pm 2^\circ\text{C}$ temperature atmosphere.

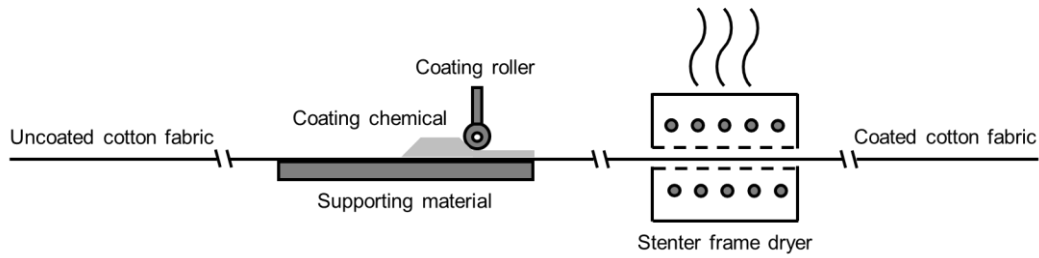

Figure 8. Schematic illustration of sample preparation through single-layer coating method

First, the cotton fabric samples were cut up according to the dimensions of the sample mounting head/frame. Then, the fabric sample was mounted over the frame. After mounting, the casein solution was spread over the fabric sample with a spatula so that the amount of solution applied was three times the weight of the uncoated cotton fabric sample. Simultaneously, the coating on the solution-steeped fabric sample was evened out by pressing very gently with a rotary bar while adjusting the pressure and speed. Casein solution coated fabric sample was then placed over a pin frame (stenter frame) in open-width stretched form to avoid any unevenness and dried at 100°C in the lab-scale hot air dryer (stenter frame dryer) for uniform drying. The process was repeated to produce the replicas of coated cotton fabrics for each casein solution respectively, according to the defined experimentation as specified in Table 4. Then, the total dry solid uptake (add-on/weight-gain) for casein coated fabric samples was calculated according to the gravimetric principle from the weight of fabric samples by using Equation 1.

Table 4. Details of alkaline and acidic casein coated cotton fabrics

Sample ID	Casein solution concentration	Sample ID	Casein solution concentration
	alkaline pH conditions		acidic pH conditions
CF_50 g/l casein-alkaline	50 g/l	CF_50 g/l casein-acidic	50 g/l
CF_100 g/l casein-alkaline	100 g/l	CF_50 g/l casein-acidic	100 g/l
CF_150 g/l casein-alkaline	150 g/l	CF_50 g/l casein-acidic	150 g/l

4.2.7 Sample preparation of casein in combination with ammonium polyphosphate bilayer coated cotton fabrics

The double coatings (double-/bi- layer coatings/assemblies) of different concentrations of CAS and APP solutions were applied on cotton fabric (CF) by a coating method as demonstrated in Figure 9 using the lab-scale bar/roller coating unit in 30±2% relative humidity 30±2°C temperature atmosphere.

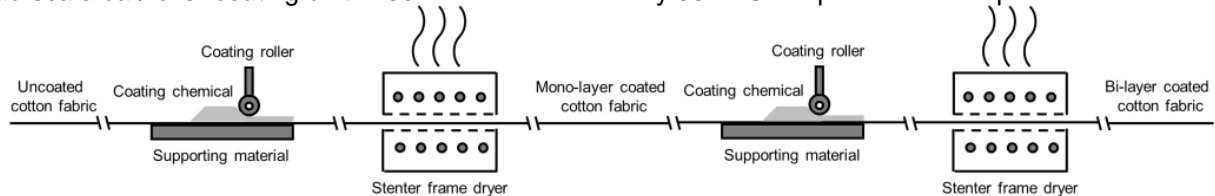

Figure 9. Schematic illustration of sample preparation through double-layer coating method

First, the cotton fabric samples were cut up according to the dimensions of the sample mounting head/frame. Then, the fabric sample was mounted over the frame. After mounting, the casein solution was spread over the fabric sample with a spatula so that the amount of solution applied was three times the weight of the uncoated cotton fabric sample. Simultaneously, the coating on the solution-imbued fabric sample was evened out by pressing very gently with a rotary bar while adjusting the pressure and speed. The casein coated fabric sample (monolayer coated) was then placed over a pin frame (stenter frame) in open-width stretched form to avoid any unevenness and dried at 100°C in the lab-scale hot air dryer (stenter frame dryer) for uniform drying. After drying, the casein monolayer coated fabric sample was again mounted over the frame. After mounting, the APP solution was spread over the fabric sample with a spatula so that the amount of solution applied was three times the weight of the uncoated cotton fabric sample. Concurrently, the coating on the solution-imbued fabric sample was evened out by pressing very gently with a rotary bar while adjusting the pressure and speed. The casein-ammonium polyphosphate (CAS-APP) coated fabric sample (bilayer coated) was then again placed over a pin frame (stenter frame) in open width stretched form to avoid any unevenness and dried at 100°C in the lab-scale hot air dryer (stenter frame dryer) for uniform drying. The process was repeated to produce the replicas of CAS-APP bilayer coated cotton fabrics for different bilayer assemblies of CAS and APP solutions respectively, according to the defined experimentation as presented in Table 5. Then, the total dry solid uptake (add-on/weight-gain) for CAS-APP bilayer coated fabric samples was calculated according to the gravimetric principle from the weight of fabric samples by using Equation 1.

Table 5. Details of CAS-APP bilayer coated cotton fabrics

Sample ID	1 st coating layer	2 nd coating layer
	CAS solution concentration	APP solution concentration
CF_CAS _{5%} +APP _{2.5%}	5%	2.5%
CF_CAS _{5%} +APP _{5%}	5%	5%
CF_CAS _{5%} +APP _{7.5%}	5%	7.5%
CF_CAS _{10%} +APP _{2.5%}	10%	2.5%
CF_CAS _{10%} +APP _{5%}	10%	5%
CF_CAS _{10%} +APP _{7.5%}	10%	7.5%
CF_CAS _{15%} +APP _{2.5%}	15%	2.5%
CF_CAS _{15%} +APP _{5%}	15%	5%
CF_CAS _{15%} +APP _{7.5%}	15%	7.5%

4.2.8 Sample preparation of casein and polyvinyl alcohol based bicomponent composite nanoparticles coated cotton fabrics

The casein/polyvinyl alcohol (CAS/PVA) nanoparticles (i.e., bicomponent composite nanoparticles) were deposited on cotton fabric (CF) by electro spraying method as demonstrated in Figure 10 using the lab-scale Elmarco's Nanospider. Electro spraying is a well-known robust and versatile technique of liquid atomization and is based on similar principles of the electro spinning method. It principally involves electrohydrodynamic processes where a polymer solution can be sprayed in the form of fine mist and/or fine droplets employing a high-potential electric field. The polymer droplets are highly charged, which prevents coagulation and stimulates self-dispersion that results in producing particles of micro and/or nano size range as uniform coatings (i.e., layers or films) on the surface of different types of substrates. Electro spraying technology has also been potentially attempted and successfully employed, as a promising coating technique, to coat textile substrates. Elmarco's Nanospider NS 1WS500U (needleless setup), is a wire electrode-based nanofiber-producing needleless electro spinning machine. It is based on "free surface technology" and generates nanofibers owing to the potential difference between two wire electrodes. In current research work, this needleless system was used for electro spraying to produce and deposit nanodroplets/nanoparticles on the surface of cotton fabric. The final blended solutions of polymers for electro spraying, i.e., CAS/PVA blended solutions were prepared by mixing the individually prepared aqueous solutions of CAS and PVA, in different specific proportions to achieve the desired compositions, according to the defined experimentation as described in Table 6. After mixing, the CAS/PVA solutions of different compositions were homogenized under continuous magnetic stirring/agitation (300 rpm) at room temperature for 5 min. Then, the blended solution of polymers was filled in the reservoir (equipped with a small orifice) of a solution-carriage. The lower wire electrode (stainless-steel wire of 0.2 mm diameter) was passed through an orifice (with a 0.7 mm inner diameter that allows the solution to come in contact with wire) of the reservoir in a concentric manner after mounting the solution-carriage on its support in the electro spinning/electro spraying chamber. The lower wire electrode was moved at a very slow speed of 0.5 mm/s in order to replenish the electro spinning/electro spraying surface, as a solid film was formed over it by polymers solution. The polymer solution was coated on this lower wire electrode (positively charged) through a solution-carriage. The carrier was moved on the wire at 200 mm/s speed, while, the airflow into the chamber was 80 m³/h and out of it was 130 m³/h. These ambient conditions inside the closed chamber were controlled through a built-in system included in the machine. The relative humidity and temperature were kept constant (30 ± 2% RH and 30 ± 2°C) and adjusted by controlling the conditions of the lab room using an electronic system. As the solution-carriage shuttled back and forth on the wire, an even layer of the polymer solution was coated on its surface. Under the action of electrostatic force, fine spray jets of polymers solution were emitted from the surface of the wire (positive electrode) and started to move toward the upper wire (negative electrode). These fine spray jets were prevented to reach the upper wire by a cotton fabric (i.e., collector substrate) and collected on its surface in the form of nanodroplets/nanoparticles. The process was repeated to produce the replicas of CAS/PVA electro spray coated cotton fabrics for all final CAS/PVA blended solutions so as to coat the surface of cotton fabrics with CAS/PVA nanoparticles of different compositions, according to the described procedure and the suitable defined parameters of experimentation, as summarized in Table 6. All these parameters were specifically selected on the basis of previous studies in the related research field and subsequently were finalized after conducting a number of experimental trials (pre-trials before final samples development). After sample preparation, the surface morphology and other results were evaluated from the scanning electron microscope (SEM) images at different magnifications. Moreover, the average size of CAS/PVA nanoparticles, deposited on the surface of cotton fabrics, was measured by observing the SEM images on the "Image J" software.

Table 6. Details of CAS/PVA electro spray coated cotton fabrics and input variables

Sample ID	CAS solution concentration	PVA solution concentration	CAS/PVA blended solution composition	Applied voltage	Electrodes distance
CF_CAS/PVA-75:25			75:25		
CF_CAS/PVA-50:50	10%	10%	50:50	65 kV	20.5 cm
CF_CAS/PVA-25:75			25:75		

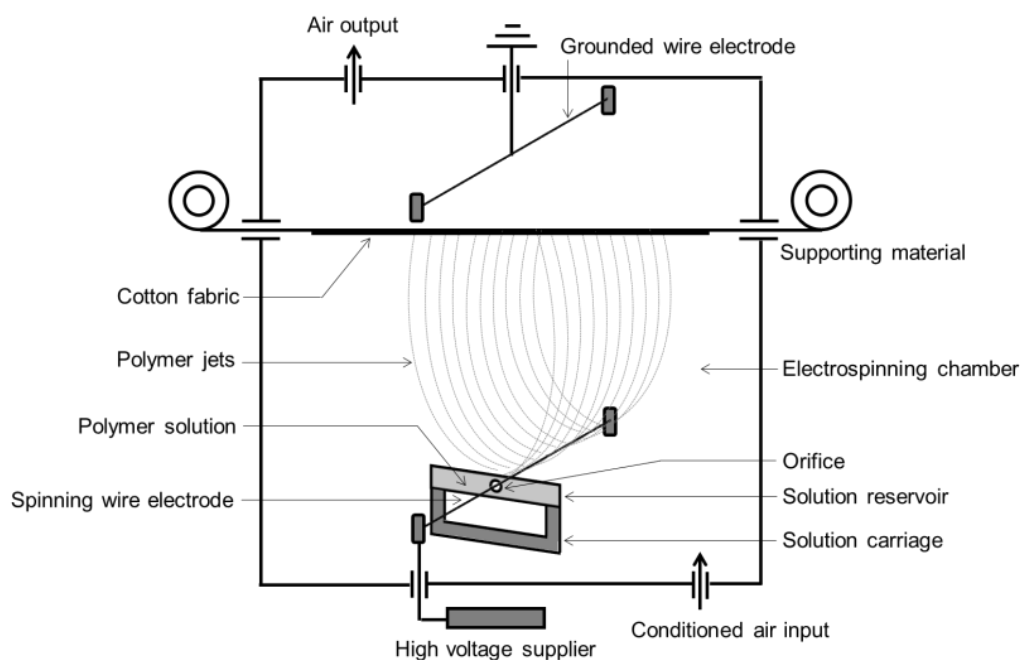

Figure 10. Schematic illustration of sample preparation through electrospaying method

4.2.9 Sample preparation for crosslinking of casein with cotton fabrics

The solutions of crosslinking/binding chemical agents of 5% concentration were applied on 30% casein concentration treated cotton fabric samples separately as an after-/post-treatment finishing process using the lab-scale padding mangle/machine (two bowl/roller vertical padding unit) and stenter dryer (pin frame drying unit). This finishing process was executed by applying the glutaraldehyde, citric acid, tannic acid, Texapret LF resin, and tetraethoxysilane chemicals solution according to the pad-dry-cure method at the suitable and applicable conditions of impregnation time, drying/curing time, and temperature. The casein treated cotton fabric sample was first immersed for 5 min in the pad/treatment bath containing a crosslinking chemical solution. Simultaneously, the solution-impregnated fabric sample was squeezed while passing through padding rollers to remove excess solution as well as to uniformly impart wet pick up of solution on the weight of the fabric. The solution padded fabric sample was then placed over a pin frame (stenter frame) in open-width stretched form to avoid any unevenness and dried at 85°C and cured at 150°C for 3 min in the lab-scale hot air dryer (stenter frame dryer) for uniform drying and curing. The after-/post-treatment finishing process was repeated for casein treated cotton fabrics applying each crosslinking chemical formulation respectively, according to the described procedure. Subsequently, all fabric samples after/post treated with glutaraldehyde, citric acid, and Texapret LF resin were thoroughly washed in warm water and dried, except only that, after/post treated with tetraethoxysilane were first rinsed with ethanol, then thoroughly washed with warm water and dried. The after/post treated fabric samples were washed to remove the unreacted deposits of crosslinking chemicals from their surface.

4.2.10 Characterization and testing

The different types of measurements, characterization, and testing techniques were employed in the research work. The intended significance of using these methods was to determine, investigate and evaluate the different parameters, features and properties of solutions, control/pristine and developed/prepared cotton fabrics. These methods are depicted in the flow chart diagram as shown in Figure 11 and explained in the following sections. All fabric samples were conditioned, in a standard atmosphere with 65±2% relative humidity and 20±2°C temperature for 24 h, according to the standard test method ISO 139, before conducting any characterization and testing.

The different specifications of bleached 100% cotton woven fabric are given in Table 1. These parameters of control cotton fabric were determined according to the standard test methods as mentioned in Table 7.

Table 7. Cotton fabric specifications analysis

Fabric specification	Standard test method
Fiber contents/composition	ISO 1833-11
Weave structure/pattern	ISO 7211-1
Number of ends and picks	ISO 7211-2
Warp and weft yarns count	ISO 7211-5
Areal density	ISO 3801
Fabric thickness	ISO 5084
Fabric absorbency	AATCC 79
pH of fabric	AATCC 81
Fabric porosity	Volume porosity
Tegewa rating of fabric	Tegewa solution test

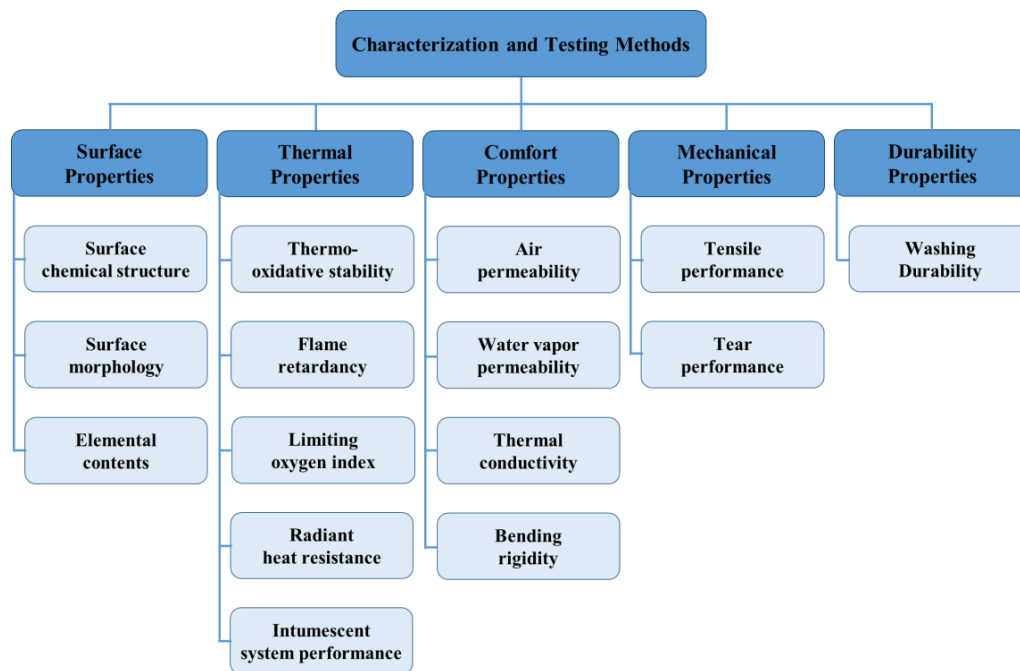

Figure 11. Characterization and testing techniques

Surface chemical structure

The surface chemical structure of cotton fabric samples was assessed by the fourier transform infrared (FTIR) spectra. The FTIR spectra of all fabric samples were recorded on an attenuated total reflectance-fourier transform infrared ATR-FTIR spectrometer (Nicolet iN10 MX, Thermo Fisher), at room temperature in the spectra range between 4000-400 cm^{-1} , by using the ATR reflection technique on an adapter with a crystal of ZnSe. The spectra were collected as a result of 32 running scans at a resolution of 4 cm^{-1} .

Surface morphology

The surface morphology of cotton fabric samples, as well as, the charred samples of burnt cotton fabrics (char residues) obtained after the horizontal flame burning test was examined by using scanning electron microscopy (SEM). The SEM images of fabric samples and char residues were taken by using a scanning electron microscope (TS5130, Vega-Tescan) . The images were taken at different suitable accelerating voltages and magnifications with a slow-scanning speed to obtain higher-quality images.

Elemental contents

The phosphorus element content of cotton fabric samples was measured by using the inductively coupled plasma atomic emission spectrometer (ICP-AES; Optima 2100 DV, Perkin Elmer). ICP-AES (also known as inductively coupled plasma optical emission spectrometry; ICP-OES) is an analytical technique used for the detection of chemical elements.

Thermo-oxidative stability

The thermal behavior of cotton fabric samples was assessed by the TG analysis (TGA). It was conducted by using a thermogravimetric analyzer (TGA/SDTA 851, Mettler Toledo). All fabric samples were analyzed under oxidative (O_2) atmospheres, i.e., in air, to characterize thermo-oxidative processes. The fabric sample (~10 mg) was placed in an alumina crucible and distributed evenly across the pan bottom and heated in the air from 30 to 800°C at a controlled heating rate of 10°C/min.

Flammability / flame retardancy

In order to designate a realistic fire scenario and reaction to flame application, the cotton fabric samples were tested for ignitability (ease of ignition/burning) and flame propagation behavior (flame spread time/speed) in a horizontal configuration by employing a horizontal flame setup (HMFV, Sdl Atlas), according to the standard test method ASTM D4986. This setup is an essential flame chamber and is commonly used at a lab scale to determine the comparative burn rate (extent) and/or burn resistance (time of burning/total burning time) of textiles, plastics, and other automotive interior materials. A fabric sample, having a length of 100 mm and a width of 50 mm, was clamped horizontally in a U-shaped sample holder. The small ignition source was provided by a gas burner, known as a Bunsen burner. The methane flame of 25 ± 2 mm height was applied for 3 seconds (ignition time) to the shorter free-side end/edge of the fabric sample. Then, the different parameters such as total burning time (s), burning rate (mm/s), and final char residue (wt. %), for the fabric sample of specified dimensions, were recorded. Furthermore, the surface morphology of char residues obtained from burnt fabric samples was examined on a scanning electron microscope at different suitable accelerating voltages and magnifications with a slow-scanning speed to obtain higher-quality images. Irrespective of the measurement conditions of the above-described test (i.e., flame height, flame application time, fabric to flame position/angle, etc.), an additional method for flame retardancy evaluation using image analysis was also employed to detect small differences in flame propagation. The burning of fabric samples was recorded on videos using a high-speed video camera. The video file was composed of frames of size 1080x1920x3 pixels in RGB 8-bit depth at 25 frames per sec (fps) rate. The MATLAB video reader function/program was used to extract each frame as an image from a video file. These images were further modified by using basic image processing tools/operations such as conversion to grey level image; subtraction of non-burned sample for suppression of sample texture. The global thresholding (at threshold 0.3) of grey-scale images was done for conversion to binary images; morphological opening for removing small connected objects and closing for filling holes in a burned area. Finally, the length and area of the burned region for burned fabric samples were estimated for every one second interval of burning time.

Limiting oxygen index

The limiting oxygen index values of cotton fabric samples were obtained by using the digital display oxygen index apparatus (OI-1-X, Govmark) at ambient/room temperature, according to the standard test method ISO 4589-2.

Radiant heat resistance

The transmission of radiant heat (heat flux/heat flux density) through cotton fabric samples was evaluated by employing the radiant heat transmission analyzer (combustion behavior test equipment; X637 B, Wazau), according to the standard test method ISO 6942-Method B.

Thermal performance of intumescent char residues

The heat transmission characteristics of the stable structure of burnt cotton fabrics (i.e., intumescent char residues) after the flammability test were investigated by employing the thermal conductivity analyzer / thermal conductivity instrument (TCi; TCI-2-A, C-Therm). The test was conducted to evaluate and verify the working efficiency/potential of the CAS-APP intumescent system for the formation of porous foam/structure of char layer. The TCi conveniently measures the thermal conductivity of small samples/specimens using the modified transient plane source (MTPS) method that conforms to the standard test method ASTM D7984.

Air permeability

The air permeability of cotton fabric samples was measured by utilizing an air permeability tester (FX 3300, Textest AG), according to the standard test method ISO 9237.

Water vapor permeability

The relative water vapor permeability (RWVP) of cotton fabric samples was measured by utilizing a water vapor permeability instrument (Permetest device, Sensora). The Permetest device/instrument provides all kinds of measurements very similar to the standard test method ISO 11092, and the results data are evaluated by an identical procedure as required in ISO 11092.

Thermal conductivity

The thermal conductivity coefficient (λ) of cotton fabric samples was measured by utilizing an Alambeta instrument (Alambeta, Sensora). The Alambeta instrument provides all kinds of measurements very similar to the standard test method ISO 8301, and the results are evaluated by an identical procedure as required in ISO 8301.

Stiffness / Bending rigidity

The stiffness/bending rigidity of cotton fabric samples was measured by utilizing a stiffness measuring device; a bending rigidity tester (TH-7, Unireg), according to the standard test method ČSN 80 0858 (800858).

Tensile properties

The tensile strength of cotton fabric samples were measured by utilizing the tensile testing machine (TIRA test, Tira), according to the standard test method ISO 1924-2.

Tear properties

The tear strength of cotton fabric samples were measured by utilizing the tear testing machine (M006B Digital UTS International), according to the standard test method ASTM D1424.

Washing durability

The untreated and casein treated (without and with after-/post-treatment finishing) cotton fabric samples were laundered in the Electrolux-wascator (a front-loading, horizontal rotating drum type standard reference washing machine; FOM71CSL, James H. Heal), according to the standard test method ISO 6330. The ECE non-phosphate reference detergent was used and the washing temperature was 40°C.

5 Summary of the results achieved

5.1 Flame retardant performance and char formation properties of casein treated cotton fabrics

The casein uptake (add-on/weight gain) by the cotton fabrics (CF) was assessed after treatment with the casein solutions of different concentrations. The effect of different concentrations of casein solutions on the casein add-on of cotton fabrics is shown in Figure 12. The add-on was found to increase remarkably with an increase in casein concentration. It was also observed that the higher casein add-on was obtained beyond the 20% casein concentration. It was due to the increased viscosity of casein solutions usually at the higher concentrations [26] beyond 20% that results in the maximum wetting and binding of individual fibers and yarns, and ultimately retaining in the fabric structure after squeezing and drying. Furthermore, to scrutinize the flame retardant performance, the phosphorous content (P content) of casein treated cotton fabrics was also determined. When it was plotted, the phosphorous content values were found to increase with an increase in casein concentration, as shown in Figure 12.

5.1.1 Surface chemical structure

The chemical/molecular structure, of cotton fabric samples, was assessed by the ATR-FTIR spectroscopy to conform to the effective presence of casein protein on the cotton fabrics. The ATR-FTIR spectra of untreated and casein treated cotton fabrics are given in Figure 13. In the case of untreated cotton fabric, the characteristic vibration modes of cellulose were detected, i.e., $\nu(\text{OH})$ at ca. ~ 3300 , $\nu(\text{CH}_2)$ at ~ 2900 , $\delta(\text{OH})$ at ~ 1640 , $\delta(\text{CH}_2)$ at ~ 1425 , $\delta(\text{CH})$ at ~ 1370 , $\delta(\text{OH})$ at ~ 1310 , $\nu(\text{C}-\text{C})$ at ~ 1020 , $\nu(\text{OH})$ at ~ 894 cm^{-1} , etc. [27]. On the other hand, the casein treated cotton fabrics showed the additional two peaks centered at 1647 and 1530 cm^{-1} for the respective vibrations of amide I and amide II groups [28]. As, the characteristic bands, in the infrared spectra for the polypeptides and proteins, include amide I (due to the stretching vibrations of $\text{C}=\text{O}$) and amide II (due to the bending vibrations of $\text{N}-\text{H}$) bands, resulting from the amide bonds that connect the amino acids. This confirmed the presence of protein coating on the surface of cotton fibers, due to the casein film/layer. The shifting of the aforementioned peaks/bands indicated the hydrogen bond interactions between the functional groups of cotton cellulose and casein protein. Moreover, an increase in the peak intensity/height depicted the deposition of a greater amount of casein on cotton fabrics treated with higher concentrations of casein, which was also evidenced by the spectra of these cotton fabrics showing the weak characteristic signals of cellulose.

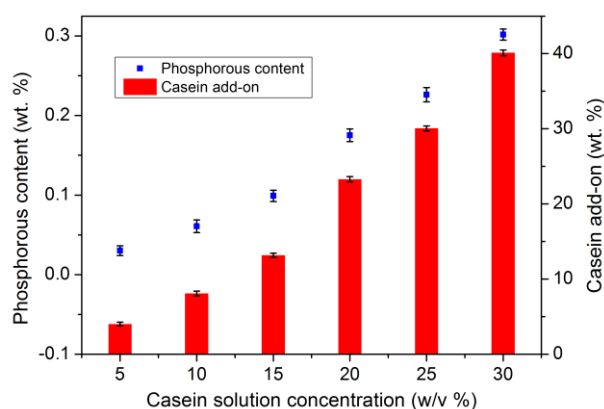

Figure 12. Add-on and phosphorous content of casein treated cotton fabrics

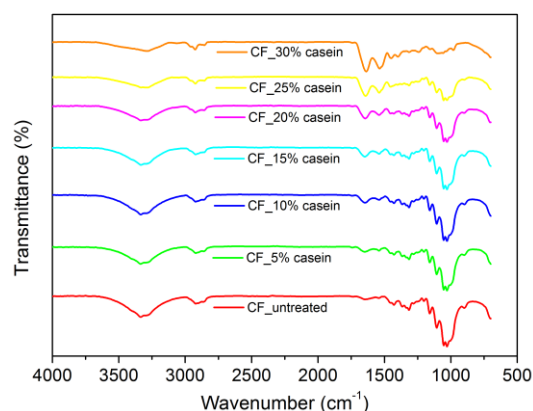

Figure 13. ATR-FTIR spectra of untreated and casein treated cotton fabrics

5.1.2 Surface morphology

The scanning electron microscopy provided information concerning the morphology of casein treated cotton fabric samples. The typical SEM micrographs of untreated and casein treated cotton fabrics are shown in

Figure 14. The treatment of cotton fabric samples; with the lower casein concentrations, exhibited distinct individual cotton fibers and yarns, whereas, with the higher casein concentrations, the individual cotton fibers and yarns were together grouped. A continuous, homogeneous, and coherent thin film/layer of casein can be observed on the cotton fibers below 20% casein concentrations. This uniform deposition of casein was found due to the maximum wetting and binding of individual cotton fibers. The absence of cracks indicated better compatibility between the casein and cotton fibers. In general, the proteins' hydrophilicity endorses their good compatibility with the polar surfaces [29], and hence, the formation of homogeneous films/layers can be attributed to the strong interactions via hydrogen bonds between the functional groups of cotton cellulose and casein protein. However, with a further increase in casein concentration beyond 20%, the film was also continuous, homogeneous, and coherent but it was thick, and therefore, the possible stiffening of fabric structure was observed due to the blocking of pores. This indicated a possible deterioration in the wearing comfort of cotton fabrics after the treatment of higher casein concentrations.

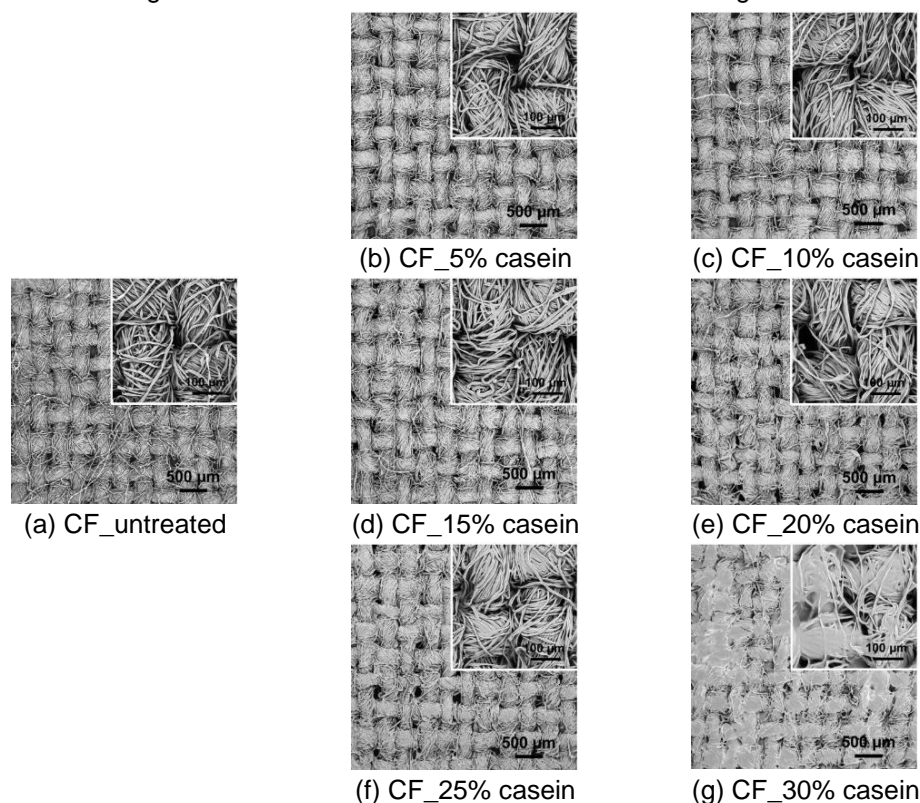

Figure 14. SEM images of untreated and casein treated cotton fabrics

5.1.3 Thermo-oxidative stability

The thermo-oxidative stability, of untreated and casein treated cotton fabrics, was assessed by the thermogravimetric analysis. The TG and DTG curves of all fabric samples were plotted, as shown in Figure 15, which represents the weight loss and weight loss rate with an increase in the temperature. The detailed characteristics data obtained from the testing results were also summarized, as given in Table 8, which presents the values of different decomposition temperatures and residue percentages for untreated and casein treated cotton fabric samples.

Table 8. Thermo-oxidative stability data of untreated and casein treated cotton fabrics

Sample	$T_{\text{onset10\%}}$ (°C)	T_{max1} (°C)	T_{max2} (°C)	Residue at		
				T_{max1} (wt. %)	T_{max2} (wt. %)	800°C (wt. %)
CF_untreated	320.11±0.51	343.33±0.23	492.17±0.45	48.1±0.3	11.3±0.4	0.0±0.0
CF_5% casein	296.33±0.71	335.95±0.19	507.83±0.65	51.9±0.5	15.8±0.2	1.3±0.1
CF_10% casein	288.50±0.66	335.50±0.21	515.67±0.59	53.5±0.4	16.7±0.3	1.7±0.1
CF_15% casein	280.67±0.59	334.64±0.20	523.43±0.73	55.3±0.6	17.9±0.2	2.5±0.2
CF_20% casein	274.71±0.81	332.75±0.25	527.50±0.57	58.9±0.7	24.6±0.4	3.1±0.1
CF_25% casein	270.83±0.75	331.43±0.32	531.33±0.69	61.2±0.5	26.1±0.3	5.9±0.2
CF_30% casein	265.53±0.93	329.25±0.35	533.82±0.71	63.4±0.7	27.7±0.5	7.6±0.2

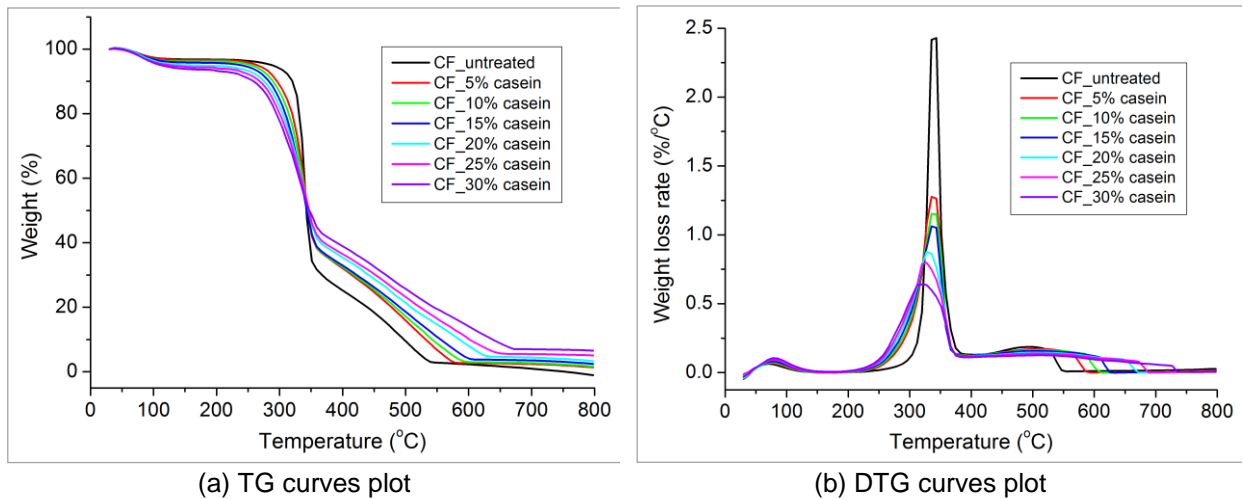

Figure 15. Thermo-oxidative stability of untreated and casein treated cotton fabrics

Insofar as the thermo-oxidative stability of cotton is cogitated, its degradation generally occurs in three main steps [30]. The first step, at 300-400°C, involves two competitive routes that produce aliphatic char and volatile products. During the second step, at 400-800°C, some aliphatic char transforms into an aromatic form generating carbon mono (CO) and carbon dioxide (CO₂), as a result of the simultaneous carbonization and char oxidation. In the last and final step, at 800°C, the char is further oxidized mainly to carbon mono- and di- oxide. In the present work, two decomposition peaks were observed between 300 and 500 °C, for the untreated cotton fabric, which was at 343°C (T_{max1}) and 492°C (T_{max2}). All fabric samples exhibited an initial mass loss in the ~50-150°C region that was attributable to the evaporation of free/residual water contained by the cotton and casein protein. Indeed, the pure proteins usually twitch to decompose at ~100°C to lose the water [31], accompanying to generate the oligopeptides and amino acids that bear carboxylic groups and possess the ability to catalyze the decomposition of cellulose. The shift of $T_{onset10\%}$ values toward the lower temperatures indicated a stronger sensitization of the cotton cellulose decomposition after the treatment with casein macromolecules. Despite these findings, T_{max1} was also altered and observed to descent. But the residue percentage after the first degradation step at T_{max1} (at 300-400°C) was higher and attributed to the formation of a thermally stable product in the form of aliphatic char. With a further increase in the temperature at T_{max2} (at 400-800°C), aliphatic char was converted to a less volatile aromatic form, yielding carbon mono and dioxide. The percentage of residue at T_{max2} was found to increase with the increase in casein concentration. This behavior was ascribed to the dehydration of glycosyl units of the cotton cellulose due to the release of acidic species (like phosphoric acids) from the casein macromolecules [31, 32].

5.1.4 Flame retardancy

The flame retardant properties of untreated and casein treated cotton fabrics were measured through the flammability tests, in terms of the limiting oxygen index (LOI) and horizontal configuration flame spread/burning tests, relating an actual fire scenario to test the flammability of textile fabrics during the prevalence of flame spread. However, the LOI measurements have a good correlation to the char formation and the results of other practically applicable testing methods [33]. The LOI value of 18.3% was obtained for the untreated cotton fabric, as due to its cellulosic nature it catches the flame/fire very quickly and burns very easily in the open atmospheric air under normal ambient conditions. The LOI value of cotton fabric was far below the flame retardant standard LOI value of 26.0-28.0% [34]. Whereas, the LOI values of casein treated cotton fabrics were found to increase noticeably from 18.7% to 23.5%, with the increase in casein concentration, as given in Table 9.

Table 9. Flammability characteristics of untreated and casein treated cotton fabrics

Sample	LOI	Total burning time	Burn rate	Char residue
	(vol. %)	(s)	(mm/s)	(wt. %)
CF_untreated	18.28±0.22	36.21±0.25	3.63±0.04	3.1±1.1
CF_5% casein	18.86±0.25	37.95±0.36	3.39±0.03	12.4±1.5
CF_10% casein	19.52±0.31	39.43±0.41	3.21±0.05	23.2±1.8
CF_15% casein	20.18±0.29	40.81±0.33	3.05±0.06	31.5±2.1
CF_20% casein	21.48±0.27	44.53±0.39	2.78±0.04	37.4±1.7
CF_25% casein	22.20±0.30	45.97±0.45	2.57±0.06	43.9±2.2
CF_30% casein	23.52±0.28	48.42±0.51	2.34±0.07	53.1±1.9

This was accredited to the enhanced char residue yields of treated fabric samples, as also revealed from the TGA results provided in Table 8, which acted as an effective thermal insulating barrier to hinder the transfer of heat and fuel and stop the combustion process. In general, an increased LOI value usually results in lower combustibility and better flame retardant properties of any polymeric materials including textile materials/substrates [34, 35], which was evinced from the horizontal flame test results such as; the total burning time, burn rate and char residue of untreated and casein treated cotton fabrics, as presented in Table 9. These observed different parameters were then used to estimate the resistance for flame propagation. The untreated cotton fabric was found to undergo vigorous and rapid combustion when a methane flame was applied for the specified time. It was completely burnt with an almost negligible amount of char residue left behind. Obviously, after ignition, the appeared vigorous flame on untreated cotton fabric was brighter all the time as compared to that on each casein treated cotton fabric sample, which conferred the fainter flames as well as the vanished afterglow phenomenon. On the contrary, the casein treatments promoted an increase in total burning time, thus exhibiting their ability for flame protection. The treated samples burnt at a slower rate and resulted in a stronger char residue while preserving the original texture of the fabrics. A substantial increase in total burning time (+34%) and a considerable reduction of burning rate (-36%), as well as a consistent final char residue (+53.1%), was found for the cotton fabric treated with 30% casein concentration. This flame retardant effectiveness of casein macromolecules was attributed to the phosphate groups located on the shell of casein micelles, which, upon heating, released phosphoric acid that favored the degradation of cellulose towards the formation of a stable char [31, 32]. Furthermore, the produced char exerted a protective effect on the underlying cotton fabric, limiting the oxygen diffusion, avoiding the formation of combustible volatile products, and absorbing the heat evolved during the combustion.

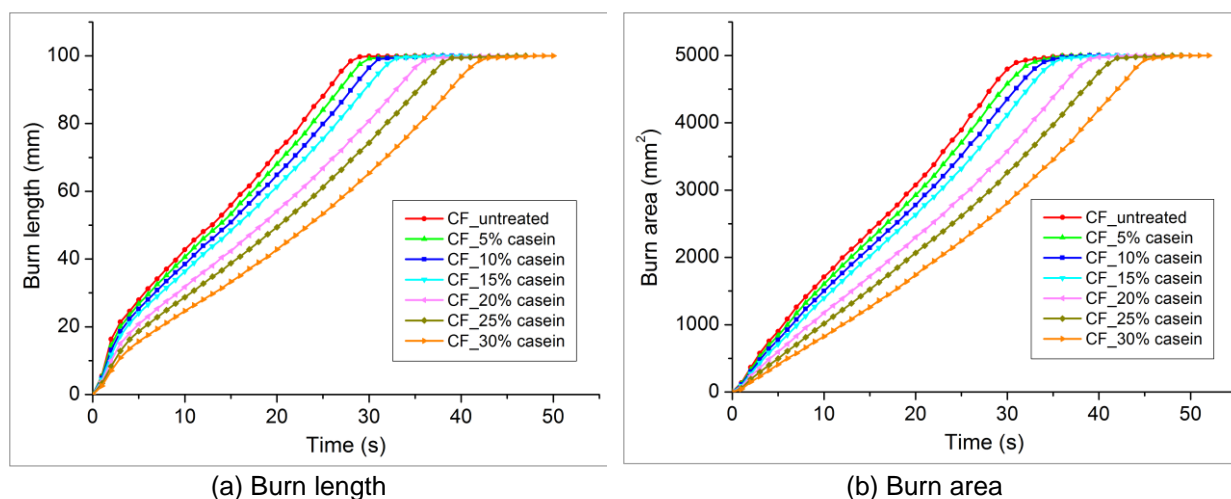
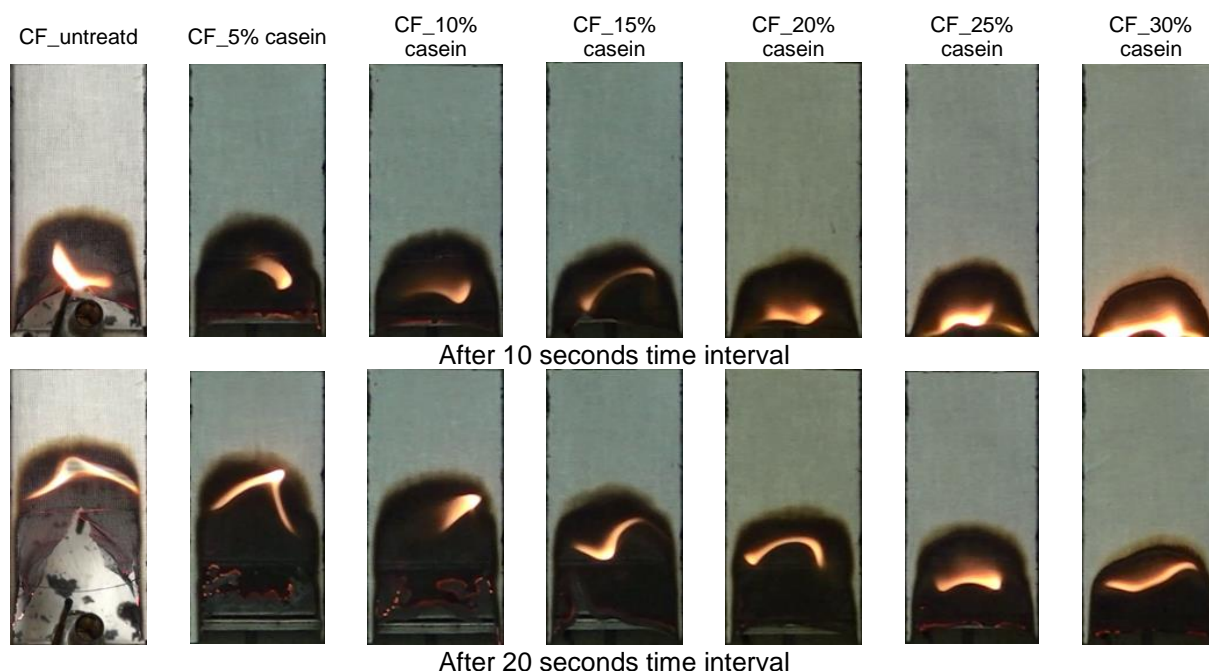

Figure 16. Plots for estimation of flame propagation with time from image analysis data



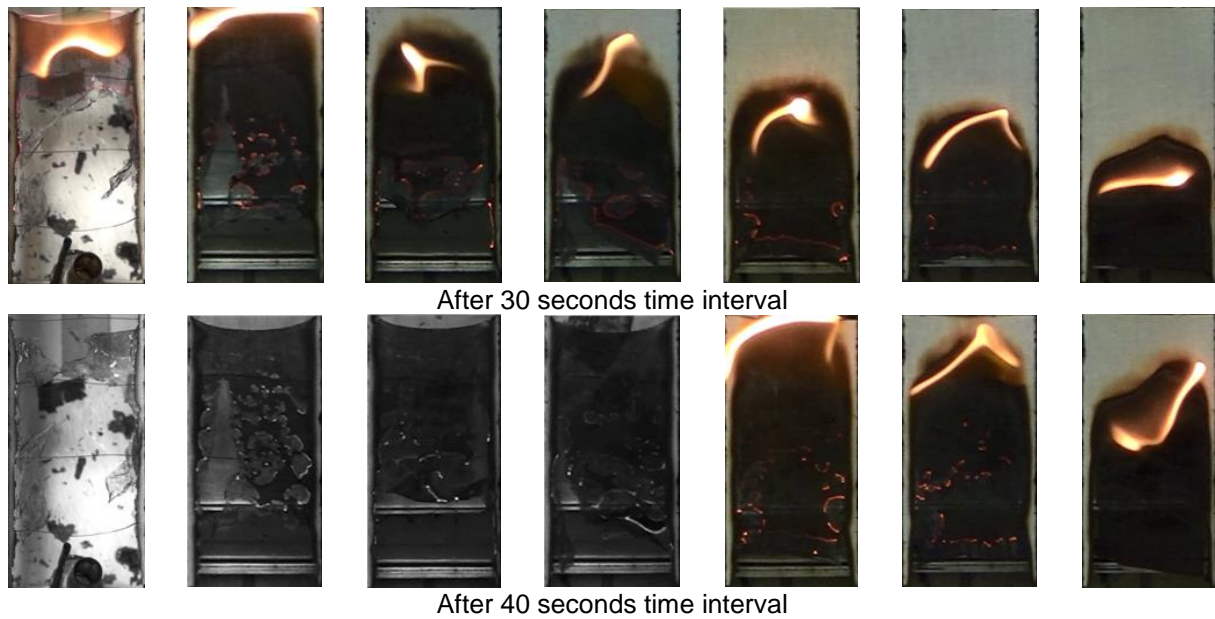

Figure 17. Photographs of burnt untreated and casein treated cotton fabrics at different time intervals during flame test

An additional method, for the flame resistance evaluation using image analysis, was employed to detect the small differences in flame propagation. Figure 16(a) and Figure 16(b) depict the burn length and burn area of untreated and casein treated cotton fabric samples with an increase of time interval in seconds. According to this analysis, the burn length and burn area plotted curves for the casein treated cotton fabric samples revealed a lesser steepness as compared to that for untreated cotton fabric. Furthermore, the steepness of curves was also observed to decrease with an increase in casein concentration. From these results, it was endorsed, a slow propagation/spread of the flame for the casein treated fabric samples and an improvement in self-extinguishing properties could be perceived for the cotton fabrics treated with higher casein concentrations. As the cotton fabrics treated with casein solutions of different concentrations exhibited lower burn length and lower burn area values as compared to that of untreated cotton fabric, this was further vindicated by the photographs of carbonized areas of all fabric samples as shown in Figure 17, which were taken after 10, 20, 30, and 40 seconds of the burning time. After the flammability test, scrutiny of the morphology of residues was also conducted through scanning electron microscopy. It revealed the preservation of the original texture of all the burnt casein treated cotton fabric samples in the form of stable and consistent char, which was verified from the SEM images, as shown in Figure 18. A very high amount of mechanically strong and extremely coherent char was observed for the burnt samples of cotton fabric treated with higher casein concentrations. The morphology of char residues of fabrics treated with higher casein concentrations indicated the formation of globular micrometric structures of phosphorus-rich bubbles that blow up during combustion [32]. The presence of bubbles in the residues was ascribed to the evolution of ammonia, released by the casein macromolecules upon heating [31, 36].

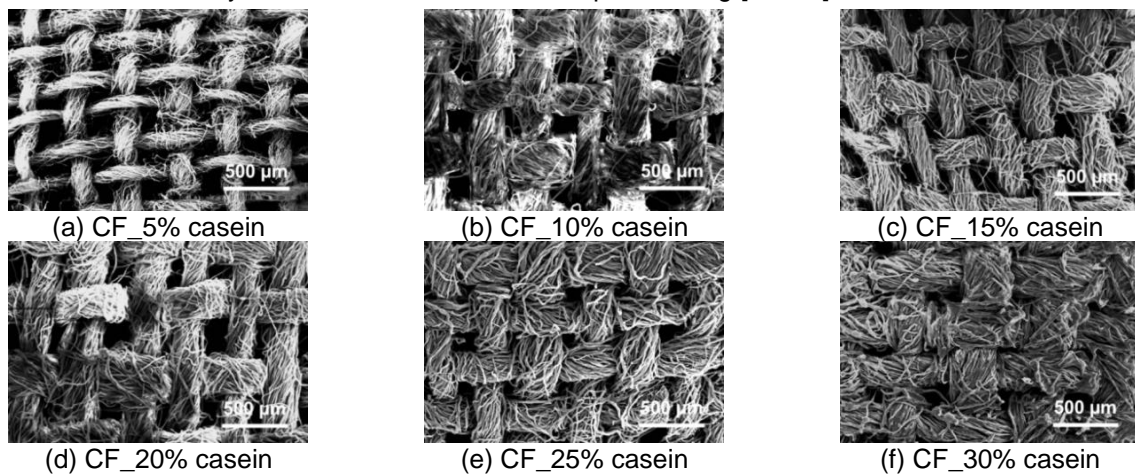

Figure 18. SEM magnifications of char residues of burnt casein treated cotton fabrics

5.1.5 Radiant heat resistance

The thermal resistance behavior, of untreated and casein treated cotton fabrics, as protection against radiant heat, was evaluated by exposing the cotton fabric samples to a radiant heat source at the specified incident heat flux density (Q_0). The rise of temperature was measured at the back of fabric samples by a

calorimeter, which subsequently resulted in; two threshold times (namely radiant heat transfer indexes), i.e., time for the rise of 12°C (RHTI₁₂) and time for the rise of 24°C (RHTI₂₄), transmitted heat flux density (Q_c) and heat transmission factor (TFQ₀), as listed in Table 10. The lower values of Q_c were noticed for casein treated cotton fabric samples as compared to that of untreated cotton fabric. Consequently, an analogous pattern was observed in TFQ₀ values, dropping from 57.8% to 42.3% for the treated cotton fabric samples with different casein concentrations. The reduction in Q_c and TFQ₀ was due to an increase in the values of RHTI₁₂ and RHTI₂₄ indexes and their difference (RHTI₂₄ - RHTI₁₂).

Table 10. Radiant heat resistance parameters of untreated and casein treated cotton fabrics

Sample	Q ₀ (kW/m ²)	RHTI ₁₂ (s)	RHTI ₂₄ (s)	RHTI ₂₄ -RHTI ₁₂ (s)	Q _c (kW/m ²)	TFQ ₀ (%)
CF_untreated	40	3.8±0.04	6.7±0.05	2.9±0.04	23.10±0.37	57.76±0.92
CF_5% casein	40	3.9±0.08	6.9±0.08	3.0±0.07	22.19±0.52	55.46±1.31
CF_10% casein	40	4.1±0.07	7.2±0.08	3.1±0.04	21.33±0.30	53.32±0.75
CF_15% casein	40	4.2±0.07	7.4±0.09	3.2±0.05	20.54±0.35	51.35±0.86
CF_20% casein	40	4.5±0.09	7.9±0.11	3.4±0.08	19.46±0.48	48.66±1.20
CF_25% casein	40	4.7±0.08	8.3±0.08	3.6±0.07	18.49±0.36	46.21±0.91
CF_30% casein	40	5.1±0.10	9.0±0.11	3.9±0.09	16.89±0.39	42.23±0.98

The higher values of radiant heat transmission indexes and their differences, for the casein treated cotton fabrics, as compared to the untreated cotton fabric, demonstrated that the temperature rise with respect to occurred at a lower rate, indicating the dilatory exchange of radiant heat towards calorimeter, i.e., the slower transmission of radiant heat. The increased values of RHTI₁₂, RHTI₂₄, and (RHTI₂₄ - RHTI₁₂) indexes were owed to the thicker casein layer/films due to the higher casein add-on as an increase in casein concentration [37–39], blocking of the spaces/interstices between the cotton fibers and yarns as corroborated from the SEM micrographs (see Figure 14). The time differences (RHTI₂₄ - RHTI₁₂) provided a good indicator of the skin pain alarm time [40], [41], as the investigation of thermal resistance performance of single-layer woven fabrics is highly relevant in order to procure and further develop the thermal protective multi-layer clothing and their overall thermal protective performance [42–47]. These larger values of (RHTI₂₄ - RHTI₁₂) for the casein treated fabric samples were endorsed for the reason that the infrared radiations which performed a pertinent part in the heat transference were also absorbed by the casein layers/films. Due to this casein layers/films provided improved thermal resistance and insulation. That might be helpful to prevent the wearer from acquiring burn injuries. Simultaneously, a reduction in the value of transmitted heat flux density, i.e., the lower quantity of transmitted radiant heat, is also considered beneficial for the textile substrate, resulting in its later on slower burning, as also validated from the flammability test results of casein treated cotton fabrics (see Table 9). More accurately, it was inferred that the resistance of casein layers/films to a radiant heat flux could also dramatically reduce the time to ignition of casein treated fabrics as compared to the untreated cotton fabric. This was accredited to the degradation/decomposition of casein to release phosphoric acid exerting a deleterious effect that sensitizes the early ignition of cotton fabric and favors the cellulose dehydration to produce more thermally stable char residues instead of volatile release [32].

5.1.6 Physiological comfort and mechanical properties

The air permeability, water vapor permeability, thermal conductivity, stiffness/bending rigidity, and tensile and tear testing, of untreated and casein treated cotton fabrics, were carried out to investigate properties connected with physiological comfort and mechanical performance, as discussed in the following sections.

Air Permeability

Despite their chemical compositions, all textile fibers are impermeable to air, and therefore, the air can only pass through a textile fabric via spaces/interstices between the fibers and yarns [48, 49]. Air permeability is interrelated to and/or affected by the characteristic structure and the ratio of empty spaces/voids (pores) in fabrics through which the air permeation eventuates. The fabrics with higher air permeability values mean that more amount of air can flow through them [50, 51]. Figure 19(a) shows the effect of casein treatments, from the solutions of different concentrations, on the air permeability of cotton fabrics. The air permeability of untreated cotton fabric was determined ~620.05 l.m⁻².s⁻¹. However, it can be seen that there is no considerable drop in the air permeability of casein treated cotton fabrics with an increase in casein concentration up to 20%. This behavior was explained by the formation of thin casein films on the surface of cotton fabric samples, which partially covered the interspaces between the fibers and yarns. Whereas, with a further increase in casein concentration beyond 20%, the air permeability of casein treated cotton fabrics was significantly dropped. The reduced airflow through these fabrics was attributed to, the closing and/or lessening of the size of inter-fiber and inter-yarn spaces/pores by the treatments of higher casein concentrations [29, 52].

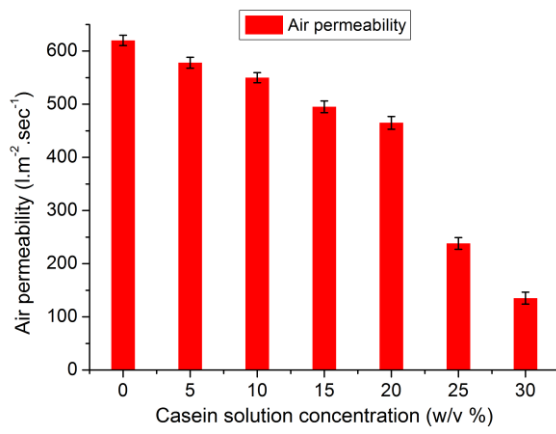

(a) Air permeability

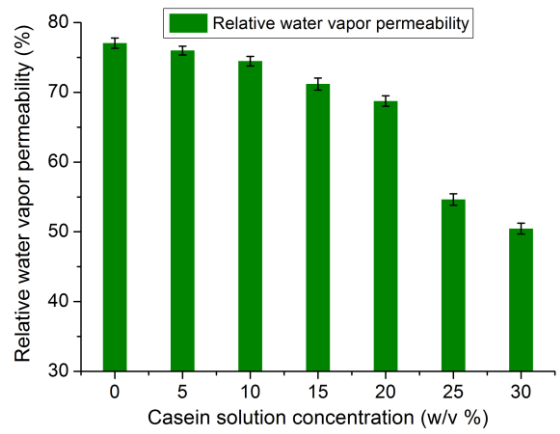

(b) Water vapor permeability

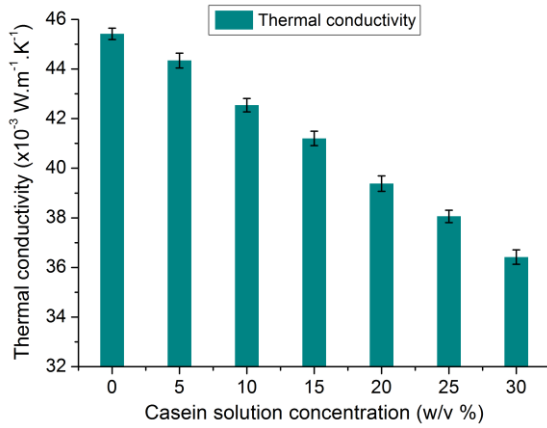

(c) Thermal conductivity

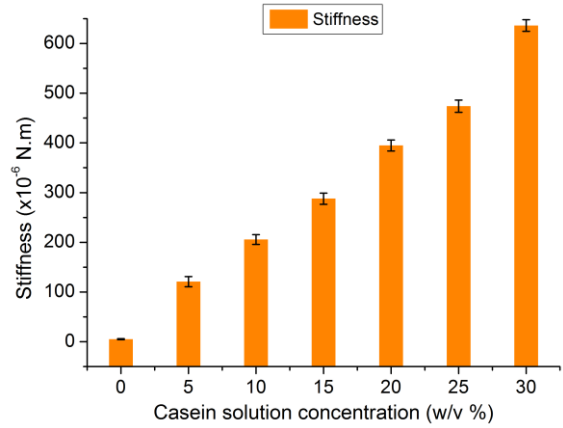

(d) Stiffness

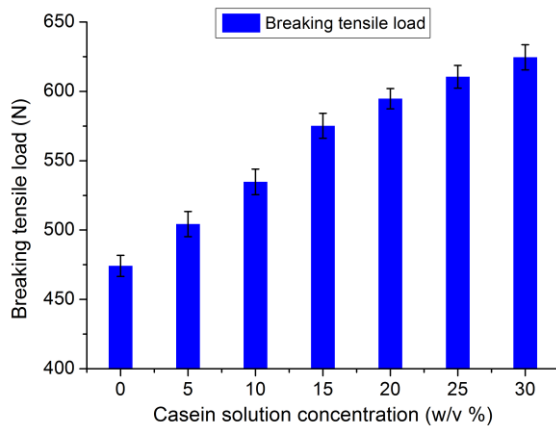

(e) Tensile strength

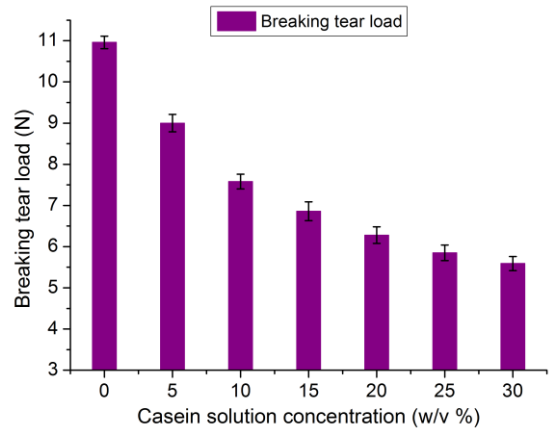

(f) Tear strength

Figure 19. Comfort and mechanical properties of untreated and casein treated fabrics

Water Vapor Permeability

Two processes are involved, when the water vapors pass through a layer of textile substrate, namely, diffusion and sorption-desorption. The diffusion rate through a textile material, at a specific concentration gradient, depends on the porosity of the textile material and also on the water vapor diffusivity of the textile fiber. It is not crucial how much water is absorbed by the fibers, but rather, how much water vapor the fibers can transport. In other words, it means, when the human body has stopped exuding sweat, the textile fabrics should release the detained water vapors to the external atmosphere, in order to lessen the humidity/moisture on the surface of the skin [48, 49]. Figure 19(b) shows the effect of casein treatments, from the solutions of different concentrations, on the relative water vapor permeability of cotton fabrics. The relative water vapor permeability of untreated cotton fabric was determined ~77.04 %. Likewise, the air permeability, a similar trend of casein treatments, was also observed for the water vapor permeability [29, 52]. The moisture vapor transport properties of treated cotton fabrics were less affected below 20% casein concentrations. The loss of moisture vapor transport, for the cotton fabrics treated with solutions of casein concentration beyond 20%, was recognized due to; the higher deposited amount of casein increasing the weight and thickness, and ultimately closing or decreasing the size of inter-fiber and intra-yarn spaces/pores [53, 54].

Thermal Conductivity

Thermal conductivity is an intensive property, of any polymeric material including textile substrates, which represents the heat transfer process by a conduction mechanism. The thermal conductivity of untreated cotton fabric was determined $\sim 45.42 \times 10^{-3} \text{ W.m}^{-1}.\text{K}^{-1}$. Figure 19(c) shows a reduction in the thermal conductivity of casein treated cotton fabrics with an increase in casein concentration. This behavior was explained by the deposition of the higher amount and/or the thick layers/films of casein on the surface of treated cotton fabric samples with an increase in the casein concentrations [55], eventually partially/fully covering the inter-spaces between the fibers and yarns. As the films produced from the casein protein usually have a rough structure and present several very small-sized pores inside their structure. The rough structure probably emanates from the substantial self-aggregation of the polar, nonpolar, and peptide chains during the drying process [56]. Perhaps, in addition to the effect of the amount/thickness of casein films, a reduction in the thermal conductivity, of casein treated cotton fabrics with higher casein concentration, might be due to the supplemental contribution and/or the effect of the entrapped air inside the inherent pores of the film structure of casein.

Stiffness

The deformation/bending properties describe the stiffness and/or flexibility of fabrics. It is a special property of fabrics, for the desirable handling, draping, and wrinkling behavior, which further can influence the physical comfort of clothing. The fabric stiffness may not be desired too high; for a considerate drape and handle in apparel, clothing, and garment fabrics, though, it may be a significant requirement, particularly for industrial fabrics. Figure 19(d) shows the effect of casein concentrations on the bending properties of cotton fabrics. The stiffness value of untreated cotton fabric was determined $\sim 5.17 \times 10^{-6} \text{ N.m}$. It was observed that the stiffness of casein treated cotton fabric samples increased noticeably with an increase in the concentration of casein solutions. This could be associated with the deposition of casein over the cotton fabric structure that formed the bridges between the fibers and/or yarns due to its gluing and binding properties [57, 58], increasing the inter-fiber/yarn friction at the fibers/yarns cross-over points (i.e., inhibiting the free movement of fibers/yarns) and making the fabric difficult to bend [50, 59]. The lower stiffness values at the lower concentration of casein below 20% indicated the lesser detrimental effect on the draping behavior of treated cotton fabrics and a satisfactory physical comfort behavior.

Tensile Properties

The tensile strength is a measure of the ability of a textile fabric, to resist breaking under tension (tensile stress), which is dependent on the length and the strength of fibers, their surface area, and also the bonding strength between them. Figure 19(e) shows the results of tensile testing and the effect of casein concentrations on the tensile breaking force (tensile breaking load/stress in newton) of cotton fabrics. The value of the breaking tensile load for the untreated cotton fabric was determined $\sim 474.18 \text{ N}$. While, it was observed that the breaking tensile load for the treated cotton fabrics increased with an increase in the concentration of casein solutions [29, 52–54]. The increased breaking force can be explained by a contribution of the load-bearing capacity of attached casein layers/films on the surfaces of fibers and yarns in the fabric structure. This can also be ascribed due to the reason that the casein solution pierces into the fabric structure during its application on the cotton fabrics through the padding method. Then it fills the spaces between the fibers and yarns and binds them together, which results in; an increase in the bending rigidity and ultimately the tensile breaking load of treated fabrics [60, 61].

Tear Properties

The tearing strength (tearing resistance) of a textile fabric corresponds to the average force applied during a tearing process, as a measure of the resistance offered by the fabric against tearing, which is likely that it relates to the fracture resistance and/or the fracture stress or the toughness of a material. Figure 19(f) shows the results of tear testing and the effect of casein concentrations on the tear breaking force/tearing force (tear breaking load/stress in newton) of cotton fabrics. The value of the breaking tear load for the untreated cotton fabric was determined $\sim 10.96 \text{ N}$. Unlike the tensile testing results, it was observed that the tearing force for the treated cotton fabrics decreased with an increase in the concentration of casein solutions [29, 52–54]. The reduced tearing force can be explained by an increase in cotton fabric rigidity after casein treatments, offering less resistance to an applied force for rupture/tearing. This can also be ascribed due to the reason that the casein solution penetrates the voids between the fibers and yarns, during its application on the cotton fabrics through the padding method. After drying the casein remains in the fabric structure and interferes with fiber-to-fiber and yarn-to-yarn interactions by binding them, which results in; a reduction of their free movement and sliding, as well as, the flexibility of fabric structure [61–64]. When the yarns are bonded together at a place in the fabric structure, the tearing force applied on individual yarns one at a time, results in a lower tearing force value.

5.2 Flame retardant behavior and inherent intumescent phenomenon of alkaline and acidic casein solutions coated cotton fabrics

The effect on the casein add-on (weight gain) of cotton fabric (CF) samples, coated with casein solutions of different concentrations (i.e., prepared under both alkaline and acidic pH conditions), is shown in Figure 20(a). The add-on was found to increase with an increase in casein concentration due to the maximum wetting and binding of individual fibers and yarns, and eventually seizing inside as well as depositing on the fabric structure after coating and drying. Further, the solution of casein prepared under an acidic pH delivered a higher add-on of casein than that of the solution prepared under an alkaline pH [26], which was explained by the observed higher viscosity of casein solutions prepared under the acidic pH conditions. Additionally, to examine the flame retardant behavior, the phosphorous content (P content) of casein coated cotton fabrics was also evaluated. When plotted, the phosphorous content values were found to increase with an increase in casein concentration, as shown in Figure 20(b).

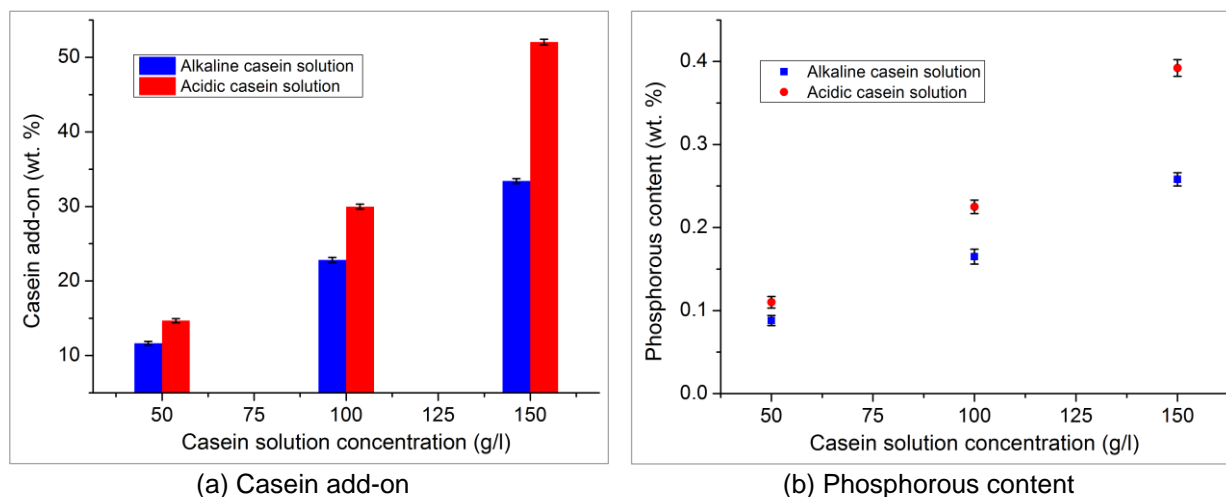
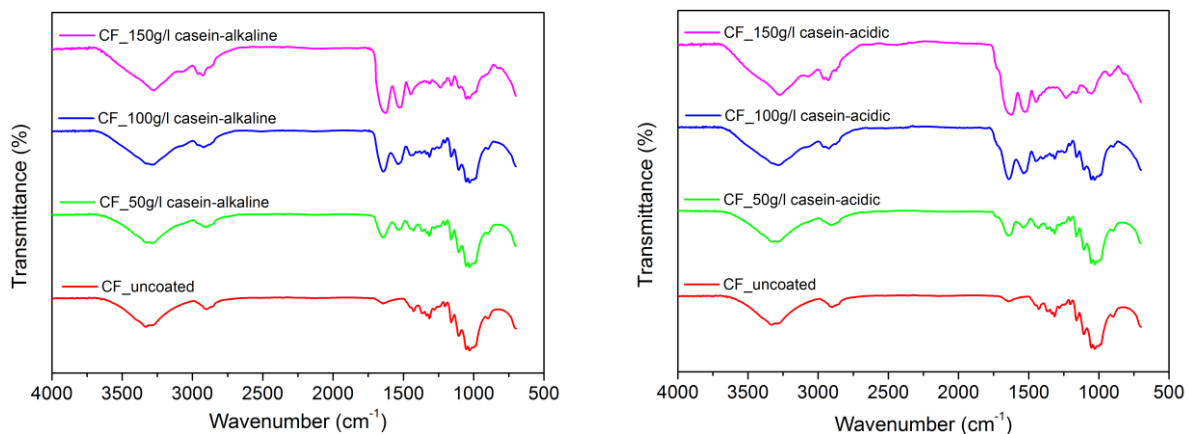

Figure 20. Add-on and phosphorous content of casein coated cotton fabrics

5.2.1 Surface chemical structure

The chemical/molecular structure, of cotton fabric samples, was appraised by ATR-FTIR spectroscopy to conform to the effectual existence of casein protein coatings on the cotton fabrics. Figure 21(a), (b) shows the ATR-FTIR spectra of uncoated cotton fabric and cotton fabric samples coated with both alkaline and acidic pH casein solutions respectively. For uncoated cotton fabric, typical vibration modes of cellulose were identified, such as; $\nu(\text{OH})$ at ca. ~ 3300 , $\nu(\text{CH}_2)$ at ~ 2900 , $\delta(\text{OH})$ at ~ 1640 , $\delta(\text{CH}_2)$ at ~ 1425 , $\delta(\text{CH})$ at ~ 1370 , $\delta(\text{OH})$ at ~ 1310 , $\nu(\text{C}-\text{C})$ at ~ 1020 , $\nu(\text{OH})$ at ~ 894 cm^{-1} , etc. [27]. As, the characteristic bands, in infrared spectra for proteins and polypeptides, include amide I (due to the stretching vibrations of $\text{C}=\text{O}$) and amide II (due to the bending vibrations of $\text{N}-\text{H}$) bands, resulting from the amide bonds that connect amino acids. Therefore, the two other peaks, located at 1624 and 1528 cm^{-1} , were substantially attributed to the respective vibrations of the amide I and amide II groups of casein. The same peaks were also credited to the presence of end amino acids; the respective asymmetric and symmetric vibrations of $-\text{NH}_3^+$ groups [28]. Furthermore, the cotton fabrics coated with the acidic casein solutions exhibited one another band at 1710 cm^{-1} , which was manifestly endorsed for the protonation of casein protein macromolecules that were dissolved in water under acidic pH conditions [65, 66].



(a) ATR-FTIR spectra of alkaline casein coatings

(b) ATR-FTIR spectra of acidic casein coatings

Figure 21. ATR-FTIR spectra of uncoated and casein coated cotton fabrics

Moreover, the deposition of a greater amount of casein on fabric samples for the acidic casein solutions was confirmed based on their higher peak intensities, and that was also supported by the spectra of these fabrics showing the weak characteristic signals of cellulose.

5.2.2 Surface morphology

The scanning electron microscopy rendered information relating to the morphology of casein coated cotton fabric samples. Figure 22(a) to (f) shows the characteristic SEM micrographs of cotton fabrics coated with both alkaline and acidic casein solutions of different concentrations. The uniform deposition of casein was observed on the coated cotton fabrics and the absence of cracks indicated the better compatibility between the casein protein and cotton cellulose fibers for both solutions. The coating of a low concentration of alkaline casein solution exhibited distinct individual cotton fibers than the coating of acidic casein solution (see Figure 22(a), (b)). However, the grouping of individual cotton fibers increased with an increase in casein concentration (see Figure 22(c) to (f)). Moreover, both casein solutions were found to produce continuous, homogeneous, and coherent coatings. But, the greater deposited amounts and/or thickness of casein coatings were obtained in the case of acidic casein solutions, due to their higher viscosity than the alkaline casein solutions [67]. This indicated higher chances of possible deterioration in the wearing comfort of cotton fabrics after coating with an acidic casein solution than an alkaline casein solution.

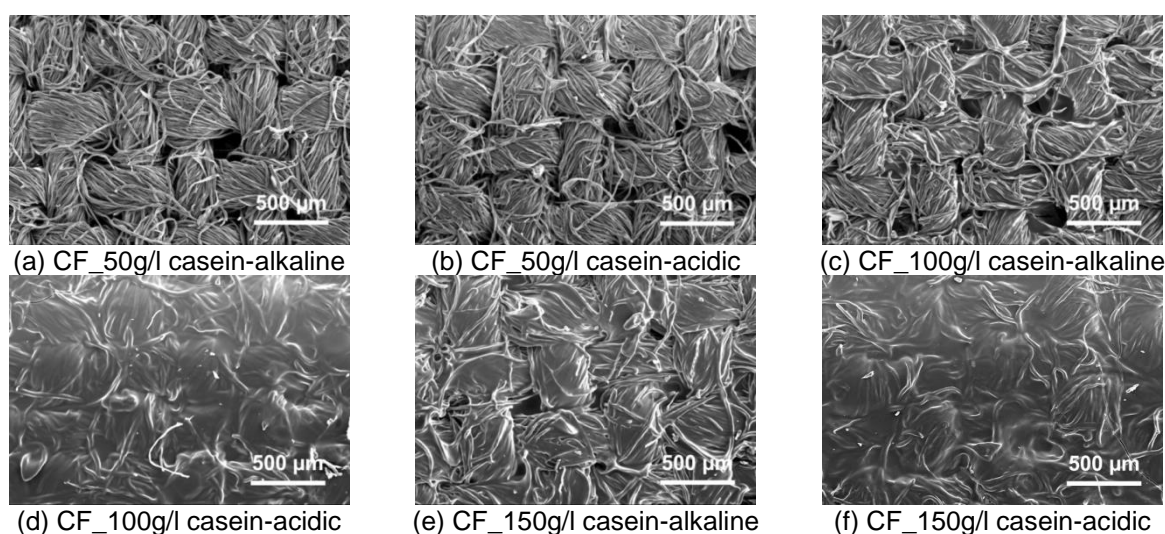

Figure 22. SEM images of casein coated cotton fabrics

5.2.3 Thermo-oxidative stability

The effect of alkaline and acidic casein solutions' coatings on the thermo-oxidative stability of cotton fabrics was analyzed through thermogravimetric analysis. The plots of TG and DTG curves of all fabric samples were drawn, as shown in Figure 23, which represents the weight loss and weight loss rate with an increase in the temperature. The widespread characteristics data achieved from the testing results were also abridged, as given in Table 11, which presents the values of different decomposition temperatures and residue percentages of uncoated and casein coated cotton fabric samples. As far as, the thermo-oxidative stability of cotton is contemplated, its degradation generally occurs in three main steps [30]. The first step, at 300-400°C, involves two competitive routes that produce aliphatic char and volatile products. During the second step, at 400-800°C, some aliphatic char transforms into an aromatic form generating carbon mono (CO) and carbon dioxide (CO₂), as a result of the simultaneous carbonization and char oxidation. In the last and final step, at 800°C, the char is further oxidized mainly to carbon mono- and di- oxide. In the present work, two decomposition peaks were observed between 300 and 500 °C for the uncoated cotton fabric at 343°C (T_{max1}) and 492°C (T_{max2}). The reduced decomposition temperatures in the first step were confirmed from $T_{onset10\%}$ and T_{max1} values, which were discerned to shift to much lower temperature in the case of cotton fabric samples coated with acidic casein solutions than those with alkaline casein solutions. The shifting of $T_{onset10\%}$ to lower values indicated stronger sensitization of the cellulose decomposition after coating with casein macromolecule solutions prepared under different pH conditions. The residue percentage after the first degradation step at T_{max1} (at 300-400°C) was observed to increase. It was attributed to the formation of a thermally stable product in the form of aliphatic char that subsequently delayed the second degradation step of fabrics coated with the higher casein concentrations, as evidenced by an increase in T_{max2} values. With a further increase in temperature at T_{max2} (at 400-600°C), aliphatic char was converted to a less volatile aromatic form, yielding carbon mono and dioxide. The residue percentage at T_{max2} was also found to increase with an increase in the casein concentrations.

Table 11. Thermo-oxidative stability data of uncoated and casein coated cotton fabrics

Sample	$T_{\text{onset10\%}}$ (°C)	T_{max1} (°C)	T_{max2} (°C)	Residue at		
				T_{max1} (wt. %)	T_{max2} (wt. %)	600°C (wt. %)
CF_uncoated	320.11±0.51	343.33±0.23	492.17±0.45	48.1±0.3	11.3±0.4	2.3±0.3
CF_50g/l casein-alkaline	289.15±0.58	334.43±0.21	523.50±0.51	54.3±0.5	22.9±0.3	14.5±0.2
CF_100g/l casein-alkaline	280.63±0.74	332.25±0.35	526.16±0.47	56.1±0.4	27.1±0.2	16.4±0.4
CF_150g/l casein-alkaline	272.83±0.69	330.31±0.29	530.43±0.63	59.9±0.6	31.4±0.4	19.2±0.3
CF_50g/l casein-acidic	275.51±0.61	328.15±0.26	538.10±0.49	62.8±0.3	24.5±0.2	15.9±0.3
CF_100g/l casein-acidic	270.16±0.71	325.83±0.37	541.33±0.54	64.6±0.5	28.8±0.3	20.5±0.5
CF_150g/l casein-acidic	263.33±0.83	322.33±0.41	543.67±0.65	67.2±0.7	33.4±0.5	27.6±0.4

Furthermore, the fabric samples coated with acidic casein solutions produced a higher amount of residues, at T_{max2} and 600°C, than those with alkaline casein solutions. This behavior was regarded to the higher casein add-on percentages obtained for the fabric samples coated with acidic casein solutions. However, the higher casein add-on percentage was ultimately the main cause of the growth of a higher phosphorous content (P content) on the fabric samples, as ascertained from Figure 20. Due to the higher deposited P content, a greater amount of acidic species such as phosphoric acid was released from casein macromolecules. That functioned the dehydration of more number of glycosyl units of cellulose, instead of depolymerization [31, 32], leading to the formation of higher residues at higher temperatures. Therefore due to these reasons, it was differentiated manifestly that cotton fabrics coated with both alkaline and acidic 150 g/l casein solutions produced 19.2% and 27.6% residue respectively at 600°C as compared to 2.3% of uncoated cotton fabric.

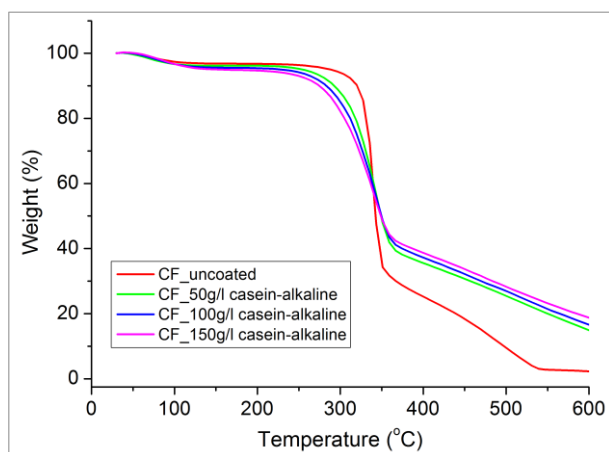

(a) TG curves plot
(coatings of alkaline casein solutions)

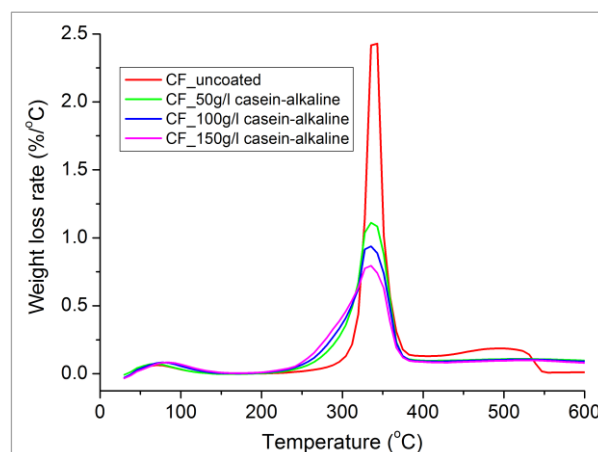

(b) DTG curves plot
(coatings of alkaline casein solutions)

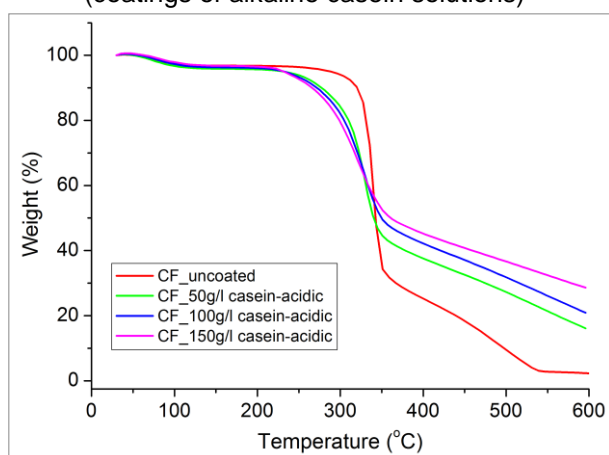

(c) TG curves plot
(coatings of acidic casein solutions)

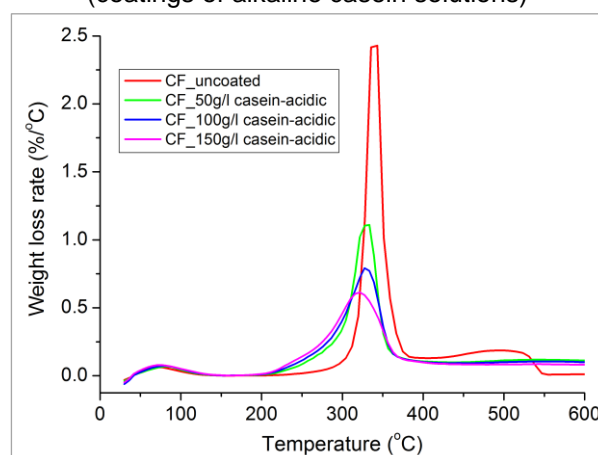

(d) DTG curves plot
(coatings of acidic casein solutions)

Figure 23. Thermo-oxidative stability of uncoated and casein coated cotton fabrics

5.2.4 Flame retardancy

The effect of alkaline and acidic casein solutions' coatings on the flame retardancy of cotton fabrics was examined through flammability tests, i.e., limiting oxygen index (LOI) and horizontal configuration flame spread tests. The LOI value of 18.3% was obtained for the uncoated cotton fabric. Nevertheless, the LOI values of casein coated cotton fabrics were found to increase considerably with an increase in casein concentration, as given in Table 12. Besides, a greater improvement of LOI values was presented by the fabric samples coated with acidic casein solutions (from 21% to 25%) as compared to those with alkaline casein solutions (from 20% to 23%). This was accredited to the enhanced char residue yields of fabric samples coated with acidic casein solutions owing to the higher deposited casein add-on percentage and phosphorous content [26, 68], as also revealed from the TGA results provided in Table 11, which acted as an effective thermal insulating barrier to hinder the transfer of heat and fuel and stop the combustion process. In general, an increased LOI value usually results in lower combustibility and better flame retardant properties of any polymeric materials including textile materials/substrates [34, 35], which was demonstrated from the horizontal flame test results such as; the total burning time, burn rate and char residue of uncoated and casein coated cotton fabrics, as presented in Table 12. These observed different parameters were then used to estimate the resistance for flame propagation.

Table 12. Flammability characteristics of uncoated and casein coated cotton fabrics

Sample	Alkaline casein solution				Acidic casein solution			
	LOI (vol. %)	Total burning time (s)	Burn rate (mm/s)	Char residue (%)	LOI (vol. %)	Total burning time (s)	Burn rate (mm/s)	Char residue (%)
CF_uncoated	18.28±0.22	36.21±0.25	3.63±0.04	3.1±1.1	18.28±0.22	36.21±0.25	3.63±0.04	3.1±1.1
CF_50 g/l casein	20.31±0.24	38.41±0.59	3.34±0.05	23.9±1.6	20.85±0.23	44.35±0.61	2.75±0.03	29.3±2.1
CF_100 g/l casein	21.63±0.25	43.97±0.73	2.83±0.04	36.5±1.8	22.48±0.24	52.41±0.78	2.31±0.05	45.1±1.4
CF_150 g/l casein	22.98±0.21	52.12±0.67	2.42±0.05	48.2±1.5	24.82±0.26	58.24±0.81	2.05±0.06	52.9±1.9

When a methane flame was applied for the specified time, the uncoated cotton fabric completely burnt vigorously without leaving any significant amount of char residue. Conversely, the casein coating treatments were found to assist an increase in the total burning time, and thus exhibited their ability for flame protection. The burning time was found to increase in a linear trend with an increase in casein concentration. Moreover, the cotton fabrics coated with both alkaline and acidic casein solutions preserved their original structure even after burning. Whereas, after burning the samples coated with acidic casein solutions preserved their original texture in the form of consistent and stable char residues even at low concentrations as compared to the less consistent and less stable, i.e., fractured structure of the char residues of samples coated with an alkaline casein solution (see Figure 22). Furthermore, the fabrics coated with acidic casein solutions burnt at a slower rate and resulted in stronger and higher char residues as compared to those treated with alkaline casein solutions. The 44% increase in total burning time, as well as 48.2% final residue, was found for the cotton fabric sample coated with 150 g/l alkaline casein solution; while, it was 61% and 52.9%, respectively for that one coated with 150 g/l acidic casein solution. This behavior was also supported by the results of TGA. Likewise, this was also construed to the obtained higher casein add-on percentage and eventually the higher phosphorous content for the fabrics coated with acidic casein solutions.

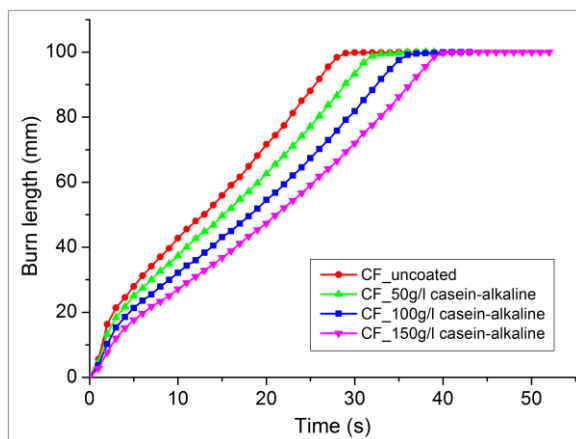

(a) Burn length

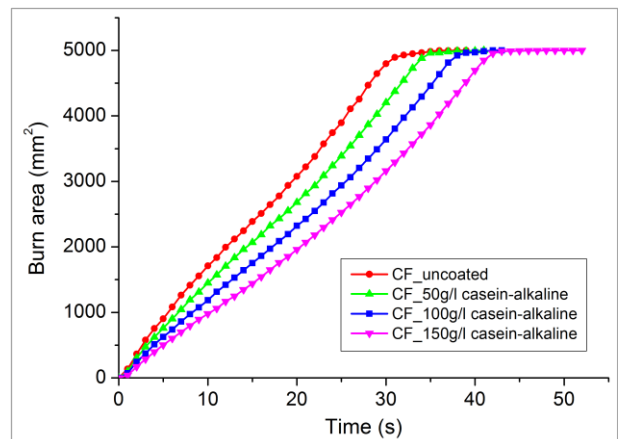

(b) Burn area

(coatings of alkaline casein solutions)

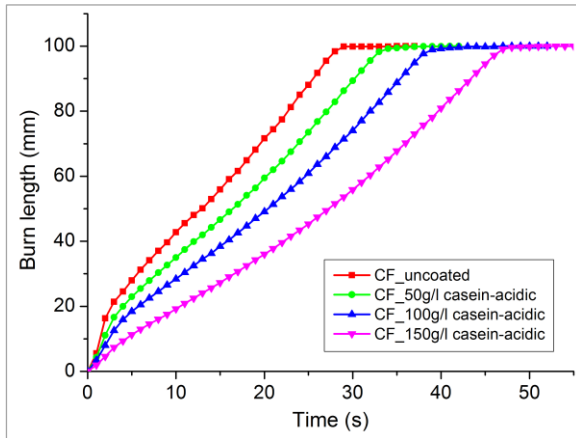

(c) Burn length

(coatings of alkaline casein solutions)

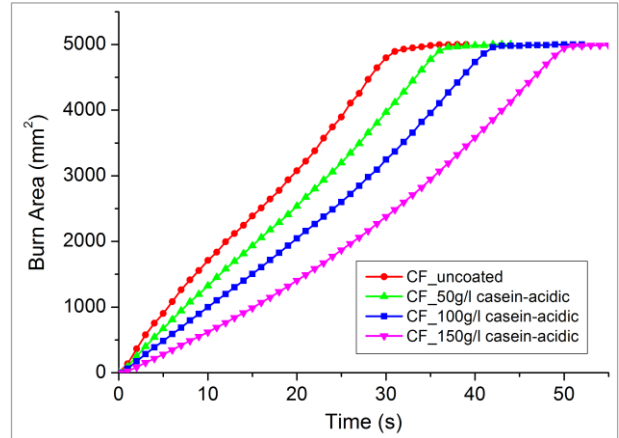

(d) Burn area

(coatings of acidic casein solutions)

Figure 24. Plots for estimation of flame propagation with time from image analysis data

Due to the deposited higher casein add-on and phosphorous content, a greater amount of acidic species like phosphoric acid was released from casein macromolecules on heating. That served the dehydration of more number of glycosyl units of cellulose, instead of depolymerization leading to a higher amount of char residues [31, 32]. The produced char also exerted a protective effect on the underlying cotton fabric, limiting the oxygen diffusion, avoiding the formation of combustible volatile products, and absorbing the heat evolved during the combustion. The image analysis tools were employed, for the estimation of flame propagation over the small intervals of time, on uncoated and casein coated cotton fabric samples. The effect of coatings, of different concentration casein solutions prepared under both alkaline and acidic pH conditions, on the burn length and burn area can be seen in Figure 24. The cotton fabrics coated with different concentrations of acidic casein solutions presented less burning behavior and revealed a lesser burn length and lesser burn area as compared to those coated with the same concentrations of alkaline casein solutions. This was further justified by the photographs as given in Figure 25 that were taken after 10, 20, 30, and 40 s of the burning time. These photographs show the carbonized areas for all samples after the specified intervals of burning time. Surprisingly, more intumescence with the release of oily substances was observed while burning of the cotton fabrics treated with acidic casein solutions. The morphology of char residues, of burnt casein coated fabrics after the flammability test, was also examined through scanning electron microscopy, which can be observed from the SEM images as given in Figure 26. The char residues of fabrics coated with alkaline casein solutions showed the formation of globular micrometric structures (i.e. local intumescence) at localized spaces (see Figure 26(a), (c), (e)).

Alkaline casein solutions
coated cotton fabrics

Acidic casein solutions
coated cotton fabrics

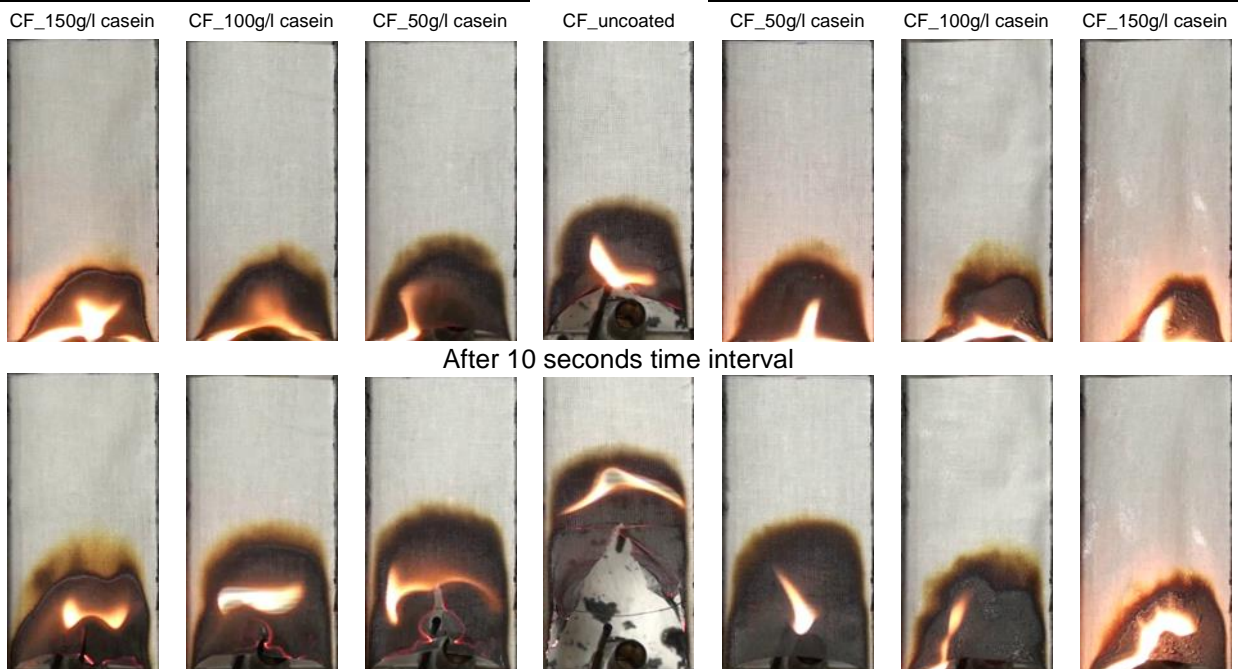

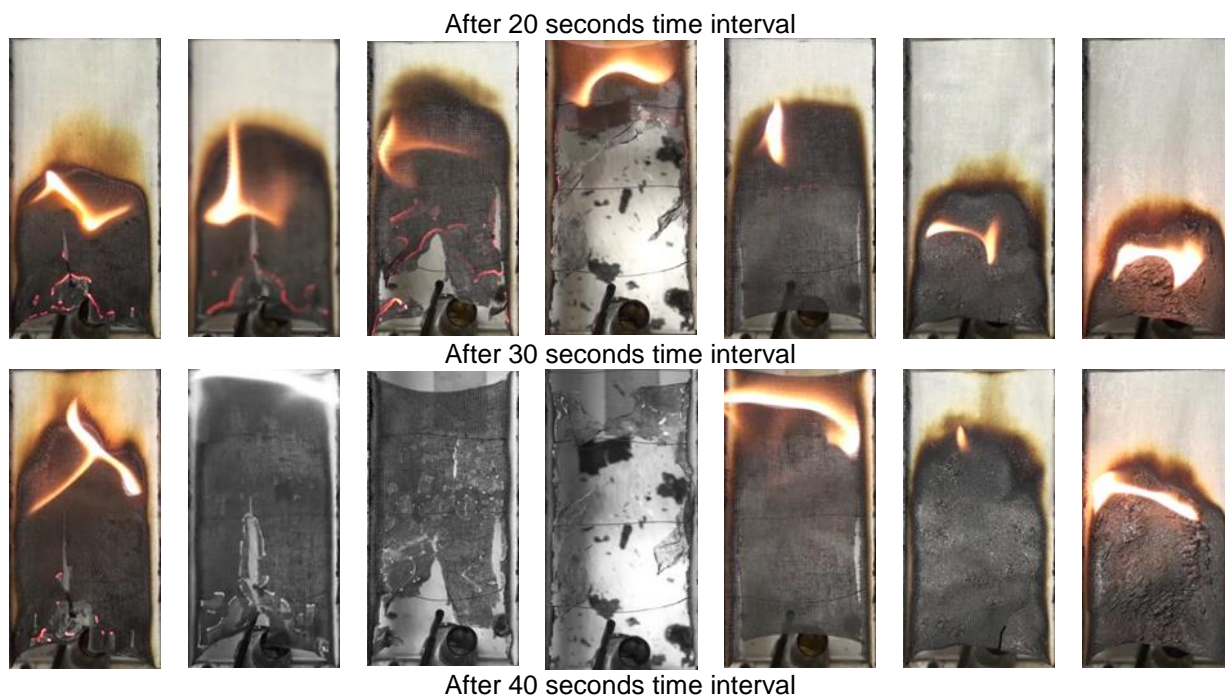
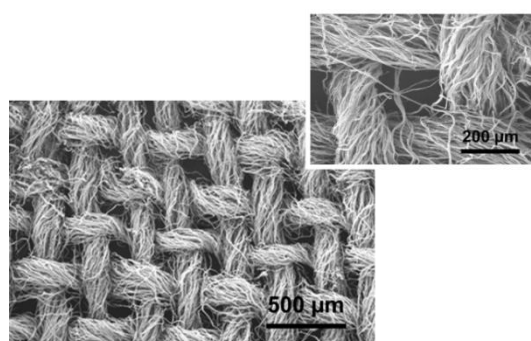
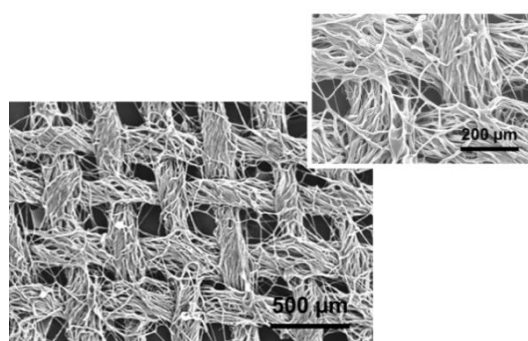

Figure 25. Photographs of burnt uncoated and casein coated cotton fabrics at different time intervals during flame test



(a) CF_50g/l casein-alkaline



(b) CF_50g/l casein-acidic

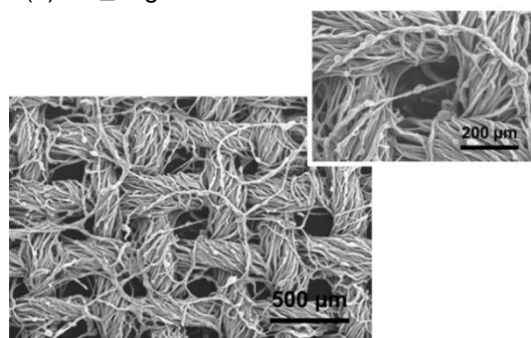

(c) CF_100g/l casein-alkaline

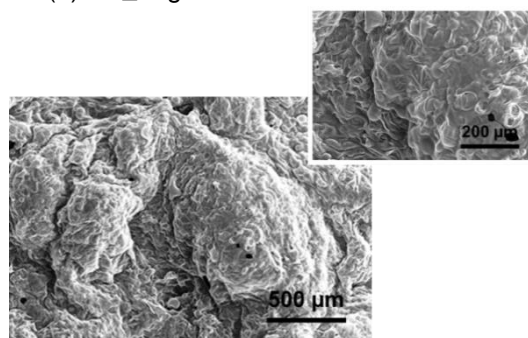

(d) CF_100g/l casein-acidic

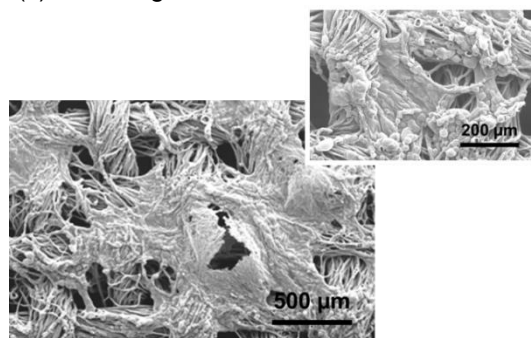

(e) CF_150g/l casein-alkaline

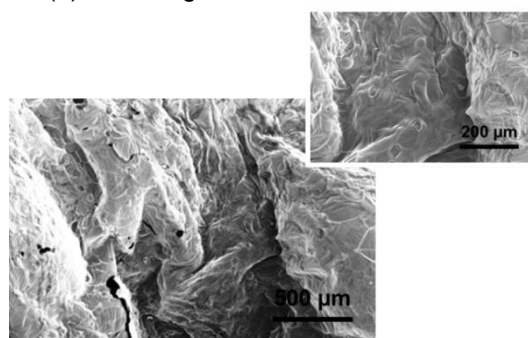

(f) CF_150g/l casein-acidic

Figure 26. SEM magnifications of char residues of burnt casein coated cotton fabrics

Contrarily, the char residues of fabrics coated with acidic casein solutions showed the formation of more expanded globular micrometric structures (i.e., global intumescence) at enlarged spaces (see Figure 26(b), (d), (f)). These micrometric structures were phosphorus-rich bubbles that blow up during the combustion, exhibiting an intumescence phenomenon [32]. The emergence of more bubbles, i.e., global intumescence, in the case of char residues of fabrics coated with acidic casein solutions, was ascribed to the release of ammonia [31, 36], comparative in higher amounts, due to the protonation of casein protein macromolecules under acidic pH conditions (see section “Mechanism of proteins behavior under different pH conditions”).

5.2.5 Radiant heat resistance

The effect of alkaline and acidic casein solutions’ coatings on the thermal resistance characteristic of cotton fabrics, as protection against radiant heat, was assessed by exposing the cotton fabric samples to a radiant heat source at the specified incident heat flux density (Q_0). The rise of temperature was calculated at the back of fabric samples by a calorimeter, which eventually resulted in; two threshold times (namely radiant heat transfer indexes), i.e., time for the rise of 12°C ($RHTI_{12}$) and time for the rise of 24°C ($RHTI_{24}$), transmitted heat flux density (Q_c) and heat transmission factor (TFQ_0), as enumerated in Table 13. A drop in Q_c values was observed for casein coated cotton fabric samples as compared to that of uncoated cotton fabric. However, the reduction in Q_c values was comparatively more in the case of cotton fabrics coated with acidic casein solutions than those coated with alkaline casein solutions. Accordingly, an identical pattern was noticed in TFQ_0 values, lowering from 57.8% to 43.3% and 57.8% to 41.0% for the cotton fabric samples coated with different concentrations of both alkaline and acidic casein solutions respectively. The reduction in Q_c and TFQ_0 was due to an increase in the values of $RHTI_{12}$ and $RHTI_{24}$ indexes and their difference ($RHTI_{24} - RHTI_{12}$). The higher values of radiant heat transmission indexes and their differences, for the casein coated cotton fabrics, as compared to the uncoated cotton fabric, highlighted that the temperature rise concerning time ensued at a lower rate, representing the tardy exchange of radiant heat towards the calorimeter, i.e., the slower transmission of radiant heat. The increased values of $RHTI_{12}$, $RHTI_{24}$, and ($RHTI_{24} - RHTI_{12}$) indexes, for the fabric samples coated with acidic casein solutions than those with alkaline casein solutions, were rendered to the comparative thicker casein coatings due to the higher casein add-on [37–39], blocking of the spaces/interstices between the cotton fibers and yarns as validated from the SEM micrographs (see Figure 22).

Table 13. Radiant heat resistance parameters of uncoated and casein coated cotton fabrics

Sample	Q_0 (kW/m ²)	$RHTI_{12}$ (sec)	$RHTI_{24}$ (sec)	$RHTI_{24}-RHTI_{12}$ (sec)	Q_c (kW/m ²)	TFQ_0 (%)
CF_uncoated	40	3.8±0.04	6.7±0.05	2.9±0.04	23.10±0.37	57.76±0.92
CF_50g/l casein-alkaline	40	4.3±0.05	7.5±0.08	3.2±0.04	20.66±0.28	51.66±0.70
CF_100g/l casein-alkaline	40	4.6±0.08	8.1±0.04	3.5±0.07	19.01±0.38	47.54±0.96
CF_150g/l casein-alkaline	40	4.9±0.07	8.7±0.09	3.8±0.05	17.33±0.25	43.32±0.61
CF_50g/l casein-acidic	40	4.4±0.05	7.7±0.08	3.3±0.04	20.04±0.26	50.10±0.66
CF_100g/l casein-acidic	40	4.8±0.04	8.4±0.05	3.6±0.05	18.18±0.27	45.45±0.68
CF_150g/ casein-acidic	40	5.4±0.08	9.5±0.04	4.1±0.09	16.39±0.36	40.98±0.89

These larger values of ($RHTI_{24} - RHTI_{12}$) for the casein coated fabric samples were accredited to the reason that the infrared radiations which performed an apposite part in the heat transference were also absorbed by the casein coatings. Due to this casein coatings provided improved thermal resistance and insulation. That might be helpful to prevent the wearer from acquiring burn injuries. Concurrently, a reduction in the values of transmitted heat flux density, i.e., the lower quantity of transmitted radiant heat, is also regarded as favorable for the textile substrate, causing later on its slower burning, as also demonstrated by the flammability test results of casein coated cotton fabrics (see Table 12). More specifically, it was concluded that the resistance of casein coatings to a radiant heat flux could also vividly reduce the time to ignition of casein coated fabrics as compared to the uncoated cotton fabric. This was ascribed to the degradation/decomposition of casein to release phosphoric acid employing a detrimental effect that sensitizes the early ignition of cotton fabric and favors the cellulose dehydration to generate more thermally stable char residues instead of volatile release [32].

Mechanism of proteins behavior under different pH conditions: Such as, the casein protein macromolecules are poly amino acids bearing several phosphate groups in their micellae structure. While, the amino acids are ampholytes; i.e., they contain both the acidic and basic groups and exhibit amphotericism, i.e., amphoteric ionic behavior [69]. Amphotericism is the reactivity of a substance, with both

acids and bases, acting as a base in the presence of an acid and as an acid in the presence of a base. However, the amino acids are basic building blocks of proteins, hence, the amphoteric ionic behavior has also been considered as one of the characteristics of proteins and attributed to the presence of amino ($-NH_2$; a basic group) and carboxyl ($-COOH$; an acidic group) groups in the side chains of the poly-peptide chain [70]. Free amino acids and peptides do not exist as non-ionic molecules; instead, they occur as zwitterions (neutral molecules). A zwitterion is a molecule that contains both the positively and negatively charged functional groups but the net charge of the entire molecule is always zero. The net charge is influenced by the pH value. Each protein has a fixed value of the isoelectric point (pI). The isoelectric point (isoionic point) is the pH value at which the number of cations is equal to that of anions. Thus, at the isoelectric point, the net electric charge of a protein is always zero. But the total charge on the protein molecule (sum of positive and negative charges) at this point is always maximum. Therefore, the proteins are regarded as the dipolar ions or internal salts or zwitterions (German for 'ion of both kinds'; amphoteric ions) at isoelectric point [71, 72], and exist in the solution as $(H_3N^+)_m - R - (COO^-)_n$. This general structure of amino acids, represented as an inner salt, was originally proposed by Adam in 1916 [73] and Bjerrum in 1923 [74]. The formula depicts the carboxyl group as being dissociated while the amino group is protonated. It means that the protein macromolecules, at pH values lower than pI, will have a net positive charge as a cation. On contrary, at pH values higher than pI, the protein macromolecules will have a net negative charge as an anion, as shown in Figure 27. While at pI, the proteins are found to be least soluble and can be precipitated most easily. Hence, any protein's solubility is highly dependent on the pH of the solution and ionic strength.

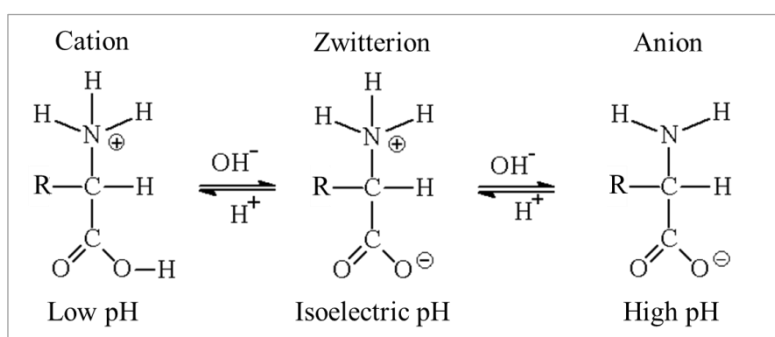

Figure 27. General mechanism for amphoteric nature of amino acids and proteins

5.3 Intumescent flame retardant system based on casein in combination with ammonium polyphosphate

The effect on the add-on (weight gain) of cotton fabric (CF) samples, coated with CAS-APP bilayer assemblies from the casein and ammonium polyphosphate solutions of different concentrations, is shown in Figure 28(a). It can be seen that the add-on of bilayer coated cotton fabric samples was increased with an increase in CAS concentration as well as APP concentration, due to the maximum wetting and binding of individual fibers and yarns, and ultimately confining inside as well as depositing on the fabric structure after bilayer coating and drying. Moreover, to predict the flame retardant function, the phosphorous content (P content) of cotton fabrics coated with the different compositions of CAS-APP bilayer assemblies were also analyzed. When plotted, the phosphorous content values of CAS-APP bilayer coatings were found to increase with an increase in CAS and APP concentrations, as shown in Figure 28(b). The maximum increase of ~9 wt. % was observed for a fabric sample coated with CAS-APP bilayer assembly of 15% CAS and 7.5% APP concentrations.

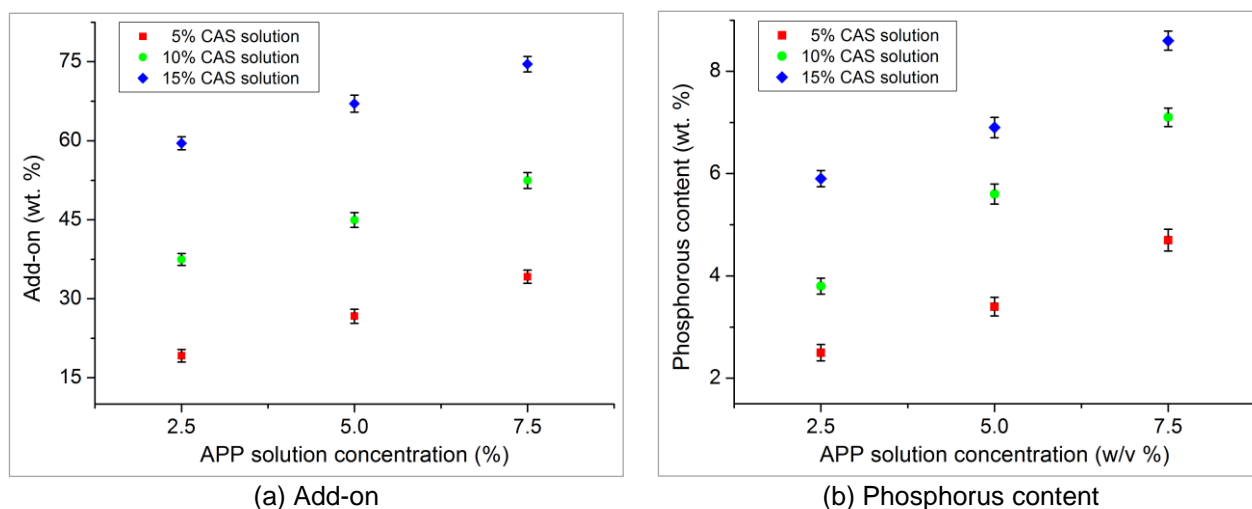

Figure 28. Add-on and phosphorous content of CAS-APP bilayer coated cotton fabrics

5.3.1 Surface chemical structure

The chemical/molecular structure, of cotton fabric samples, was scrutinized by ATR-FTIR spectroscopy to conform to the efficacy of different bilayer assemblies and the presence of CAS and APP on the cotton fabrics. The ATR-FTIR spectra, of uncoated cotton fabric and cotton fabric samples bilayer coated with different concentrations of CAS and APP, are given in Figure 29(a), (b), (c) respectively. The spectra of CAS-APP bilayer coated cotton fabrics exhibited the weak characteristic signals of cellulose backbone indicating the presence of deposited CAS-APP bilayer coatings. Besides the weak distinctive vibration modes of cellulose, namely; $\nu(\text{OH})$ at ca. ~ 3300 , $\nu(\text{CH}_2)$ at ~ 2900 , $\delta(\text{OH})$ at ~ 1640 , $\delta(\text{CH}_2)$ at ~ 1425 , $\delta(\text{CH})$ at ~ 1370 , $\delta(\text{OH})$ at ~ 1310 , $\nu(\text{C}-\text{C})$ at ~ 1020 , $\nu(\text{OH})$ at ~ 894 cm^{-1} , etc. [27], the bilayer coated cotton fabrics showed some additional peaks for the presence of CAS and APP. The two peaks, positioned at 1624 and 1528 cm^{-1} , were significantly assigned for the respective vibrations of amide I and amide II groups of casein protein [28]. As, the characteristic bands, in infrared spectra for proteins and polypeptides, include amide I (due to the stretching vibrations of $\text{C}=\text{O}$) and amide II (due to the bending vibrations of $\text{N}-\text{H}$) bands, resulting from the amide bonds that connect the amino acids. In the region, at 1500-500 cm^{-1} , many overlapped signals/peaks were present. Whereas, the two peaks located at 1250 and 884 cm^{-1} were referred to as the vibrational modes of $\text{P}=\text{O}$ and $\text{P}-\text{O}-\text{P}$ of ammonium polyphosphate respectively, accompanying the typical signals of ammonium group stretching and bending [75]. Moreover, an increase in the intensity/height of these peaks indicated the deposition of a greater amount of casein and ammonium polyphosphate on the cotton fabrics bilayer coated with the higher concentrations of CAS and APP, which was also verified by the spectra of these cotton fabrics showing the weak characteristic signals of cellulose.

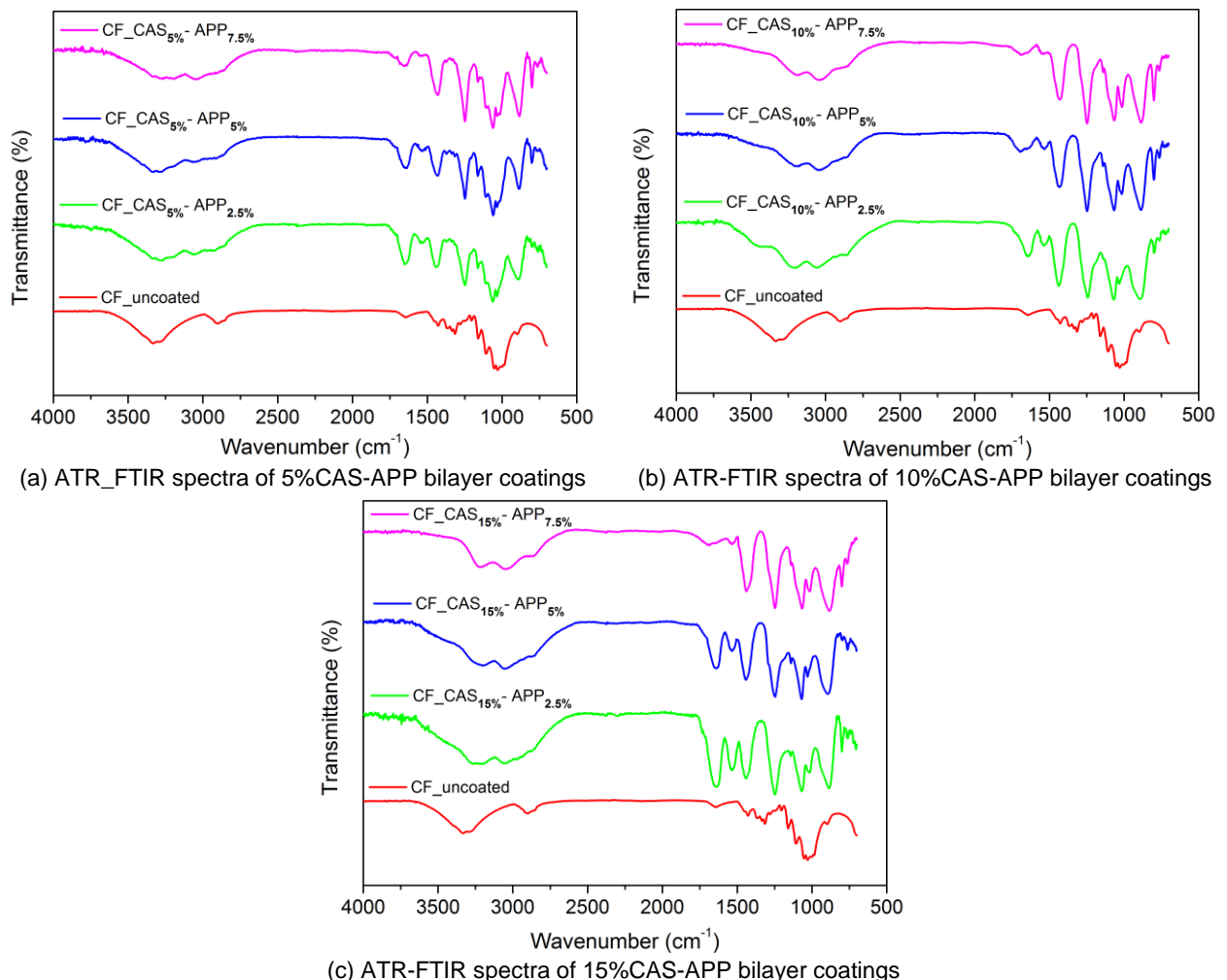

Figure 29. ATR-FTIR spectra of uncoated and CAS-APP bilayer coated cotton fabrics

5.3.2 Surface morphology

The scanning electron microscopy presented information regarding the morphology of CAS-APP bilayer coated cotton fabric samples. The representative SEM micrographs of cotton fabrics bilayer coated with different concentrations of CAS and APP are shown in Figure 30. A continuous, homogeneous, and coherent film was observed on the surface of bilayer coated fabric samples due to the maximum wetting

and binding of cotton fibers and yarns with the casein and ammonium polyphosphate solutions of different concentrations. The cotton fibers exhibited better compatibility with bilayer coatings of CAS and APP, as was evidenced by the observations of no cracks on the surface coatings. At a low concentration of CAS, the bilayer coated fabrics' surfaces showed distinct individual cotton fibers even with an increase in APP concentration (see Figure 30(a), (b), (c)). Whereas, at higher concentrations of CAS even with an increase in APP concentration, the bilayer coated fabrics' surfaces showed an increased grouping of individual fibers and yarns (see Figure 30(d), (e), (f) and also Figure 30(g), (h), (i)), which resulted in the reduction of inter-fiber and/or inter-yarn spaces/pores, due to the higher amount and thickness of deposited bilayer coatings.

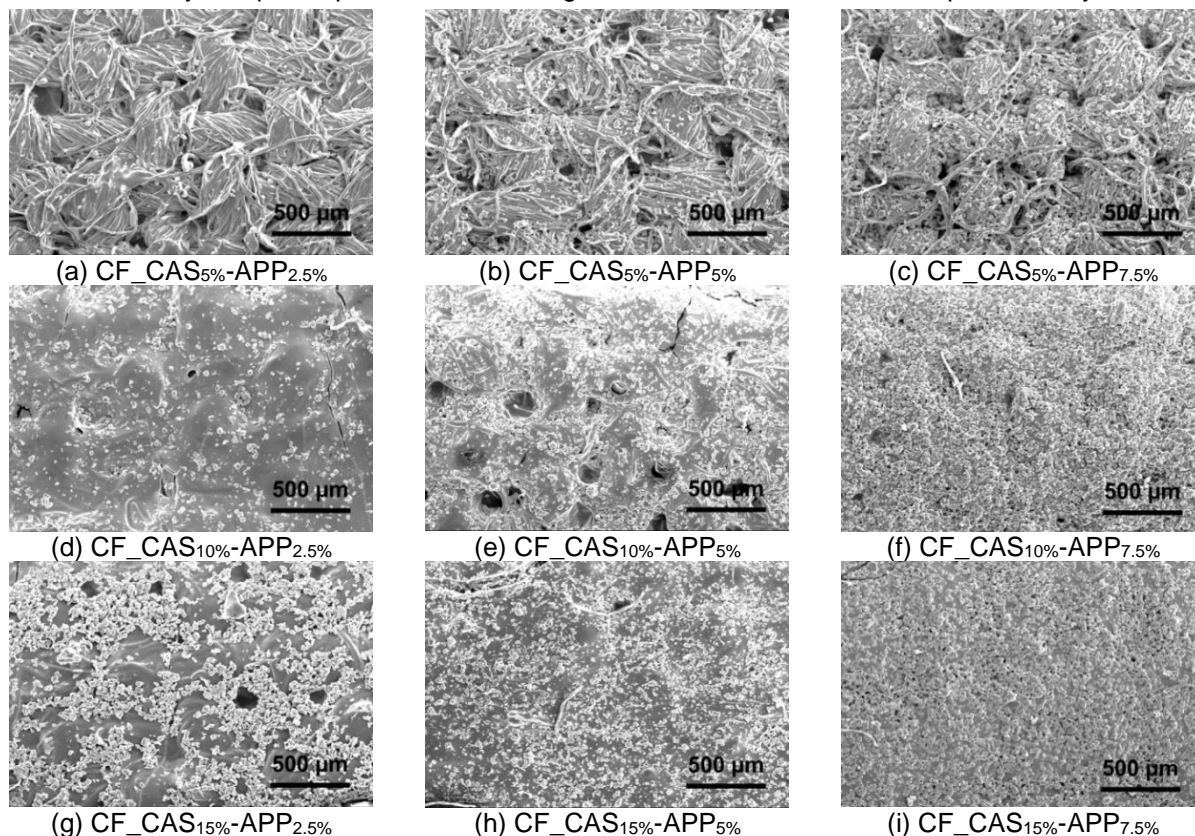

Figure 30. SEM images of CAS-APP bilayer coated cotton fabrics

5.3.3 Thermo-oxidative stability

The thermogravimetric analysis was employed to evaluate the effect of CAS-APP bilayer coatings on the thermo-oxidative stability of cotton fabrics. The TG and DTG curves of all fabric samples were plotted, as shown in Figure 31, which represents the weight loss and weight loss rate with an increase in the temperature. The broad characteristics data attained from the analysis results were also condensed, as given in Table 14, which presents the different decomposition temperatures and residue percentages of uncoated and CAS-APP bilayer coated cotton fabric samples.

Table 14. Thermo-oxidative stability data of uncoated and CAS-APP bilayer coated fabrics

Sample	$T_{\text{onset}10\%}$ (°C)	$T_{\text{max}1}$ (°C)	$T_{\text{max}2}$ (°C)	Residue at		
				$T_{\text{max}1}$ (wt. %)	$T_{\text{max}2}$ (wt. %)	600°C (wt. %)
CF_uncoated	320.11±0.51	343.33±0.23	492.17±0.45	48.1±0.3	11.3±0.4	2.3±0.3
CF_CAS5%-APP2.5%	269.50±0.42	298.13±0.29	520.11±0.49	74.2±0.3	40.7±0.2	30.9±0.3
CF_CAS5%-APP5%	265.87±0.51	293.56±0.35	525.83±0.61	75.5±0.4	42.4±0.4	33.1±0.4
CF_CAS5%-APP7.5%	262.45±0.44	290.17±0.42	531.67±0.55	77.2±0.2	44.4±0.3	35.2±0.5
CF_CAS10%-APP2.5%	264.55±0.39	292.50±0.31	528.85±0.47	76.5±0.3	43.5±0.4	34.3±0.2
CF_CAS10%-APP5%	261.43±0.41	288.15±0.45	534.48±0.58	77.9±0.4	45.1±0.3	36.8±0.5
CF_CAS10%-APP7.5%	258.12±0.51	284.67±0.51	540.21±0.66	79.6±0.3	47.4±0.5	38.9±0.4
CF_CAS15%-APP2.5%	260.33±0.43	287.10±0.33	536.43±0.54	78.8±0.3	46.3±0.3	37.9±0.4
CF_CAS15%-APP5%	256.45±0.53	283.33±0.48	541.95±0.64	80.4±0.2	48.6±0.5	40.1±0.3
CF_CAS15%-APP7.5%	253.51±0.57	280.25±0.53	547.65±0.62	82.1±0.4	49.9±0.4	42.3±0.5

It can be viewed that the thermal degradation of all samples consists of two steps, i.e., 200-400°C and 400-600°C. The decomposition of uncoated cotton fabric was started at 298°C and then the maximum weight loss rate was observed at 343°C (T_{max1}) in the first degradation step. The residue percentage after the first degradation step at T_{max1} was attributed to the formation of a thermally stable form of aliphatic char due to the depolymerization and dehydration of cellulose. Nevertheless, on a further increase of temperature, the second maximum weight loss rate appeared at 492°C (T_{max2}) during the second degradation step, which corresponded to the carbonization of aliphatic char into aromatic char and then further oxidation into carbon mono (CO) and dioxide (CO₂) [30]. The $T_{onset10\%}$ values of cotton fabric samples were noticed to shift towards the lower temperatures when coated with CAS-APP bilayer assemblies of different concentrations of CAS and APP. The effect of increasing APP concentration was found more prominent in shifting the $T_{onset10\%}$ values as compared to increasing CAS concentration. This indicated a stronger performance of ammonium polyphosphate for sensitization of the cellulose decomposition as compared to casein. Furthermore, the initial decomposition temperature (T_{max1}), of cotton fabric samples coated with different compositions of CAS-APP bilayer assemblies, was also reduced withal to a greater extent with increased concentration of APP than that of CAS due to the catalyzed thermal degradation of cotton in the presence of APP [76, 77]. The anticipated first degradation step was regarded to be advantageous for the thermal stability of cotton in the whole degradation process, because the thermo-stable carbonaceous structure, formed at lower temperatures, is obviously considered favorable to suppress the further degradation of cotton at higher temperatures. Irrespective of APP concentration, the higher concentration of CAS was found to produce a higher residue percentage at T_{max1} as evidence of the catalyzed charring of casein by ammonium polyphosphate. This subsequently resulted in, the delayed occurrence of the second degradation step as confirmed by T_{max2} values, and thus the formation of more stable char at higher temperatures compared to that of uncoated cotton fabric. However, the final char residues of CAS-APP bilayer coated cotton fabrics with CAS and APP solutions of higher concentrations evinced a large-scale growth at 600°C. This increase in catalyzed charring was ascribed to the growth of higher phosphorous content (P content) on CAS-APP bilayer coated cotton fabric samples, as shown in Figure 28(b). The fabric sample coated with CAS-APP bilayer assembly of 15% CAS and 7.5% APP concentrations produced a maximum of 42.3% residue at 600°C as compared to that of 2.3% of uncoated cotton fabric.

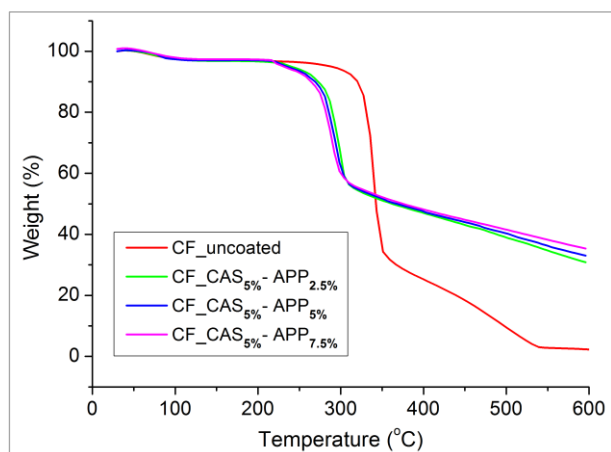

(a) TG curves plot
(5%CAS-APP bilayer coatings)

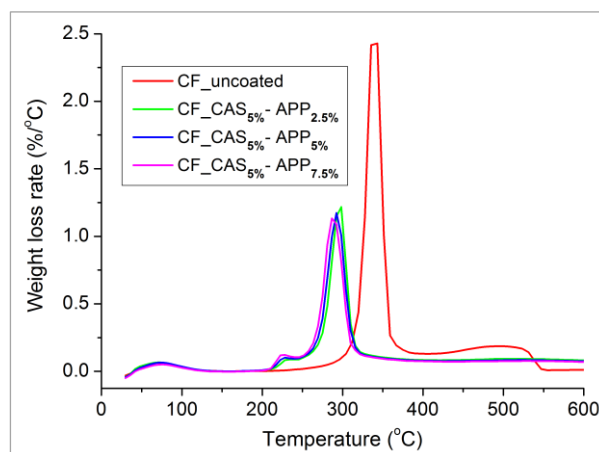

(b) DTG curves plot
(5%CAS-APP bilayer coatings)

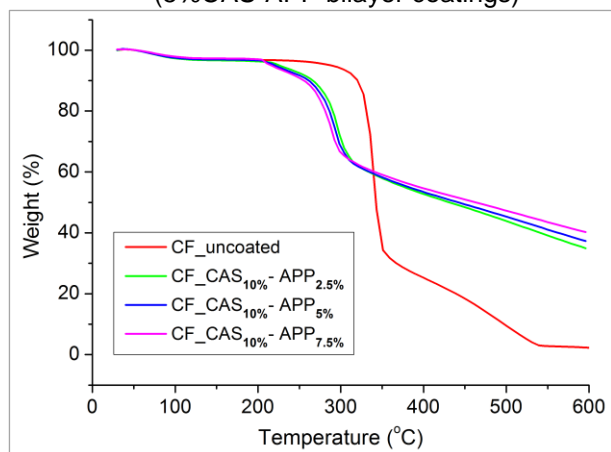

(c) TG curves plot
(10%CAS-APP bilayer coatings)

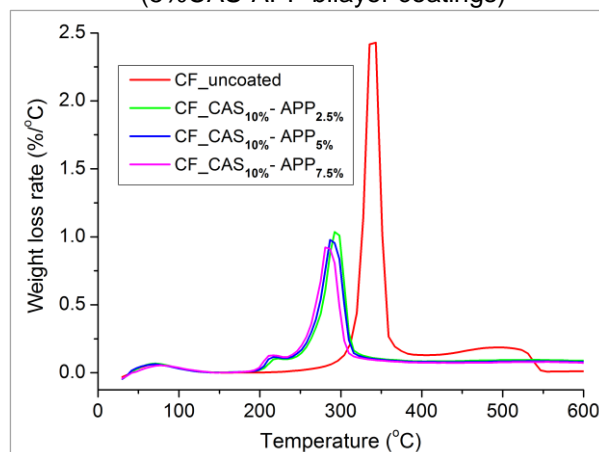

(d) DTG curves plot
(10%CAS-APP bilayer coatings)

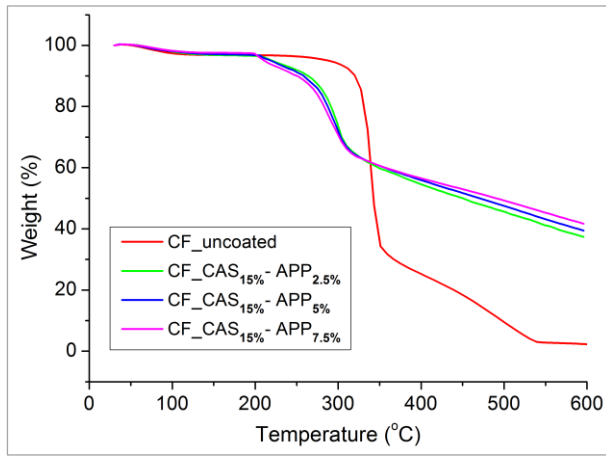

(e) TG curves plot
(15%CAS-APP bilayer coatings)

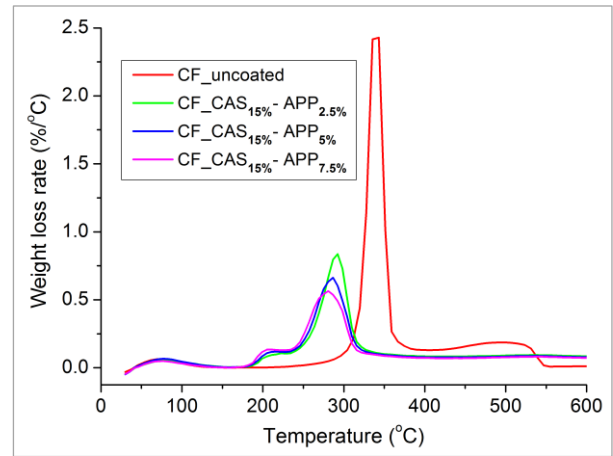

(f) DTG curves plot
(15%CAS-APP bilayer coatings)

Figure 31. Thermo-oxidative stability of uncoated and CAS-APP bilayer coated cotton fabrics

5.3.4 Flame retardancy

The flammability tests such as limiting oxygen index (LOI) and horizontal configuration flame spread tests were employed to assess the combustion behavior and flame retardant performance of CAS-APP bilayer coated cotton fabric samples. The LOI value of 18.3% was obtained for the uncoated cotton fabric. While, the LOI values were discerned to enhance significantly with the increased concentrations of CAS and APP, for the cotton fabric samples coated with different compositions of CAS-APP bilayer assemblies, as given in Table 15. This was accredited to the enhanced char residue yields of bilayer coated cotton fabrics owing to the higher deposited add-on percentage and phosphorous content [35, 68], as also revealed from the TGA results provided in Table 14, which acted as an effective thermal insulating barrier to hinder the transfer of heat and fuel and stop the combustion process. In general, an increased LOI value usually results in lower combustibility and better flame retardant properties of any polymeric materials including the textile materials/substrates [34, 35], which was corroborated by the horizontal flame test results such as; the total burning time, burn rate and char residue of uncoated and CAS-APP bilayer coated cotton fabrics, as presented in Table 15. These observed different parameters were then used to evaluate the resistance for flame propagation.

Table 15. Flammability characteristics of uncoated and CAS-APP bilayer coated cotton fabrics

Sample	LOI	Total burning time	Flame stoppage time	Char residue
	(vol. %)	(s)	(mm/s)	(wt. %)
CF_uncoated	18.28±0.22	36.21±0.25	-	3.1±1.1
CF_CAS5%-APP2.5%	27.31±0.23	-	8.43±0.17	26.8±0.8
CF_CAS5%-APP5%	29.98±0.28	-	7.15±0.23	31.2±0.6
CF_CAS5%-APP7.5%	32.79±0.25	-	5.67±0.19	34.3±0.7
CF_CAS10%-APP2.5%	31.27±0.30	-	6.46±0.21	32.6±0.6
CF_CAS10%-APP5%	34.11±0.27	-	5.15±0.17	35.7±0.5
CF_CAS10%-APP7.5%	37.45±0.24	-	3.91±0.25	39.3±0.8
CF_CAS15%-APP2.5%	35.52±0.31	-	4.75±0.19	36.9±0.6
CF_CAS15%-APP5%	38.31±0.25	-	3.41±0.21	40.8±0.5
CF_CAS15%-APP7.5%	41.27±0.29	-	2.34±0.23	43.9±0.7

Besides burning vigorously, the uncoated cotton fabric was found to leave insignificant char residue, when a methane flame was applied for a specified time. The flame lasted for approximately 36 s followed by a prolonged afterglow. On the other hand, the flame stopped after some seconds, for the cotton fabrics coated with different compositions of CAS-APP bilayer assemblies, extinguishing the flame propagation, yielding enough char residues, and showing intumescence phenomena, depending on the CAS and APP solutions of different concentrations. However, the flame stoppage time was reduced more by the coated fabrics with higher APP contents/concentrations for either any constant casein concentration in the coatings of bilayer assemblies. Furthermore, the char residues were increased more by the coated fabrics with higher casein

contents/concentrations for either any fixed APP concentration in the coatings of bilayer assemblies, which was analogous to the results of TGA. The maximum char of 43.9% was produced by a cotton fabric sample coated with CAS-APP bilayer assembly of 15% CAS and 7.5% APP concentrations as compared to that of 3.1% of uncoated cotton fabric. The burnt residues of bilayer coated cotton fabrics also perfectly maintained the weave/structure. Interestingly, for the burnt char residues of fabric samples coated with bilayer assemblies of higher casein contents for either any constant APP contents, the distinct appearance of higher intumescence phenomena was observed, in comparison with the fabrics that coated with bilayer assemblies of lower casein contents/concentrations. Therefore, an increase in casein concentration is more advantageous for the production of more intumescent char residues. These combustion behavior results proposed that the CAS-APP bilayer coatings could efficiently control the fire and ultimately lead to self-extinguishing on the cotton fabrics, acting as an intumescent flame retardant system.

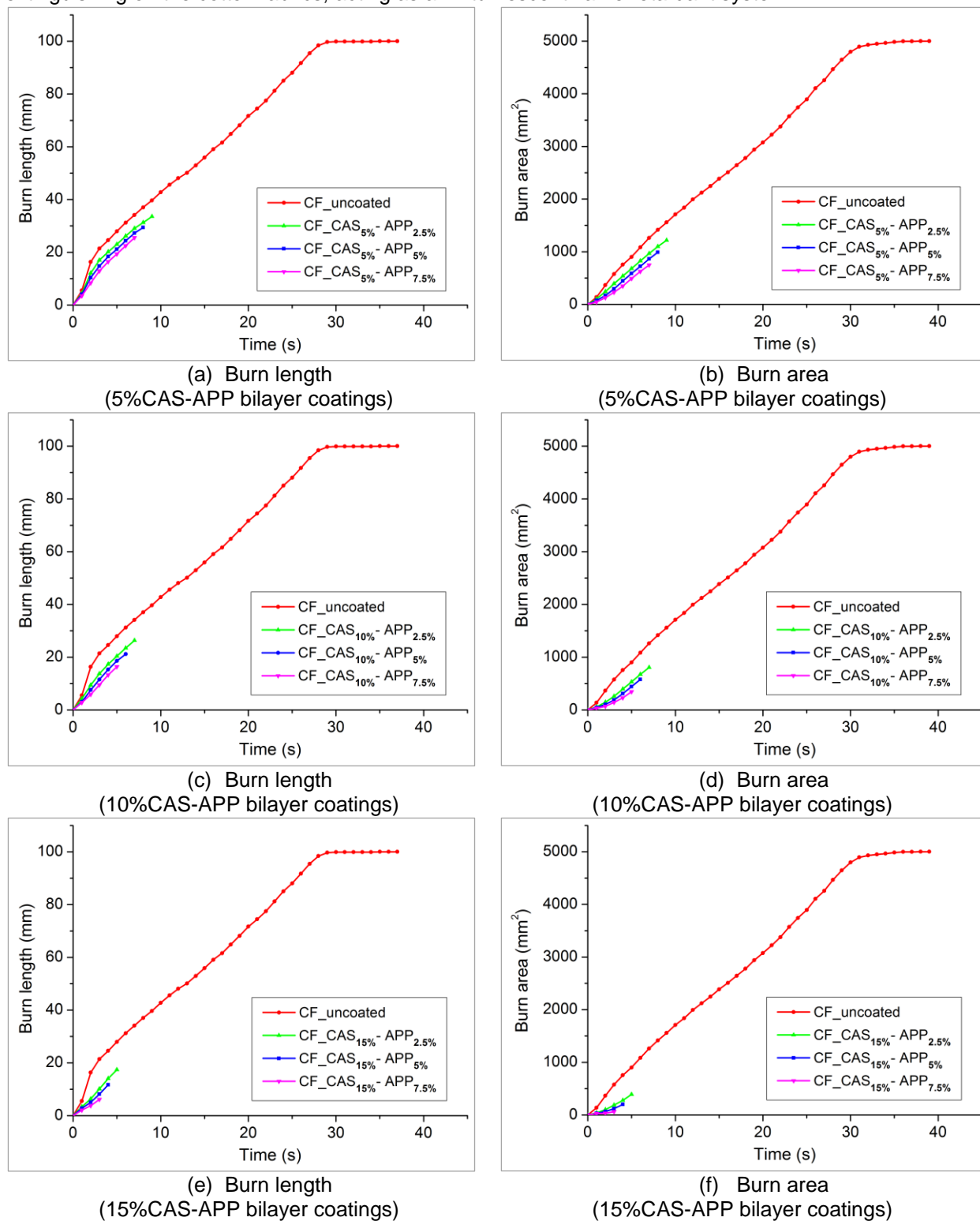

Figure 32. Plots for estimation of flame propagation with time from image analysis data

The dynamics of flame propagation were also studied using the image analysis method. It was performed to measure the changes in burn length and burn area over small intervals of time. Figure 32 shows the effect of CAS-APP bilayer assemblies of different compositions on the flame propagation dynamics of cotton fabrics. The CAS-APP bilayer coated fabric samples with higher APP contents/concentrations, for either any constant casein concentration in the coatings of bilayer assemblies, exhibited a lesser burn length and burn area. The least burning behavior among all fabric samples was observed for that one coated with a CAS-APP bilayer assembly of 15% CAS and 7.5% APP concentrations, as also affirmed in Figure 33. This behavior was credited to the greater release of phosphoric acid and ammonia, which completely extinguished the flame propagation and produced the multicellular swollen (intumescence) char residues through the catalyzed degradation of cotton cellulose and casein. Furthermore, the protective effect on the underlying cotton fabrics can be observed from the photographs of burnt fabric samples after the flame test, as given in Figure 33, which reveals the formation and presence of intumescence char layers. The produced foam of char limited the oxygen diffusion, avoided the formation of combustible volatile products, and absorbed the heat evolved during the combustion. This confirmed the promising applications of the bilayer assemblies of casein and ammonium polyphosphate for the formation of a body-fitted intumescent char layer, especially at higher casein contents.

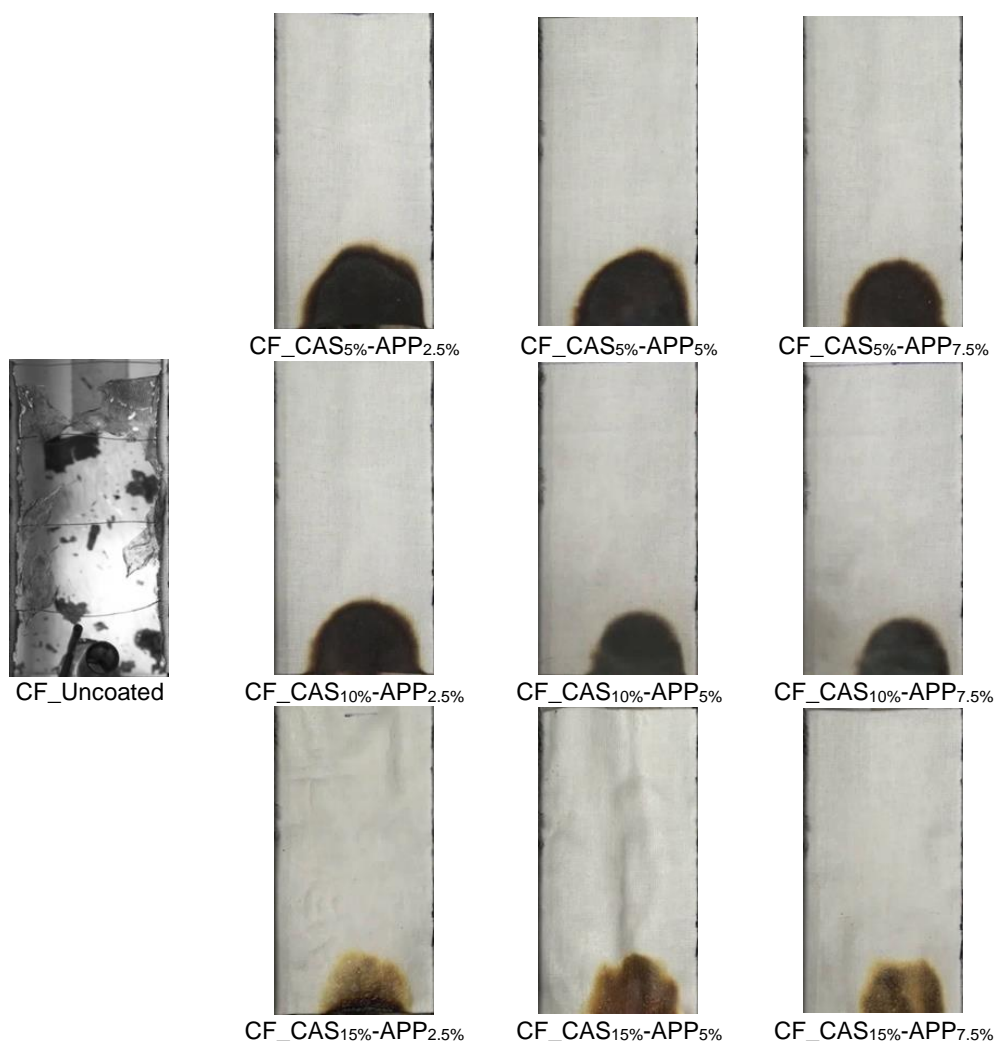

Figure 33. Photographs of burnt uncoated and CAS-APP bilayer coated cotton fabrics after flame test

Afterward, the intumescent flame retardant mechanism of CAS-APP bilayer assemblies was investigated by observing the surface morphology of burnt fabric samples through scanning electron microscopy. The SEM images of all burnt samples' residues after the flame test are given in Figure 34. It can be observed manifestly that in the case of burnt residues of the fabric samples that were bilayer coated with lower CAS and lower APP concentration, a thin protective char layer formed on the surface of fibers, containing less expanded globular micrometer structure at localized spaces (i.e., local intumescence) and few fibers fractured during the burning (see Figure 34(a)). Instead, as the APP concentration was increased in the bilayer coatings for the lower CAS concentration, the burnt residues also produced in the form of a thin protective char layer but containing a larger size and less expanded globular micrometer and bubbled structure with some cavities (see Figure 34(b), (c)). The globular micrometer structures are phosphorus-rich bubbles that blow up during combustion [32]. Contrarily, with an increase in CAS contents either for

any of fixed APP contents in the bilayer assemblies coated on cotton fabrics, the char layer became denser containing more expanded globular micrometric and porous structures at enlarged spaces (i.e., global intumescence), and the underlying weaves structures of bilayer coated fabrics greatly retained (see Figure 34(d), (e), (f) & Figure 34(g), (h), (i)). These results indicated the formation of additional char residues by the catalytic dehydration of CAS in the presence of APP, and thus the potential use of casein protein as a carbonization agent (carbon source) in intumescent systems. The greater char expansion by the release of more volatile gases (such as ammonia gas) can be validated from the observation of more bubbles in the case of higher APP contents [78–80]. Furthermore, the greater expansion of char during burning could also be attributed to the contribution of casein protein behavior as a blowing agent [31]. Therefore, the CAS-APP based intumescent systems can be considered effective and efficient as the casein protein could perform a number of functions such as catalyzed dehydration, accelerated charring, and intumescent char formation.

As the ultimate objective of an intumescence coating is the creation of a structurally stable and highly porous insulative material (tumescent/cellular/expanded/layered char) on the substrate's surface that limits heat transfer and/or heat diffusion to slow down the substrate's degradation. The thermal performance of an intumescence char is determined by its insulation characteristics, which basically depend on its structure. If the structure of char (i.e., the morphology and distribution of pores/voids inside the char) is appropriate, the thermal conductivity of intumescent chars is very low [81–85]. On these bases, furthermore, to validate the formation of voluminous char after the flame test due to the burning of CAS-APP bilayer coated cotton fabrics, the heat transmission characteristics of the residual chars were measured by using the thermal conductivity instrument (TCi). The results obtained from the analysis were the values of thermal effusivity (heat penetration coefficient) and thermal conductivity of residual chars. It can be seen from Figure 35(a), (b) that the thermal conductivity and thermal effusivity values of residual chars of burnt bilayer coated fabric samples reduced with an increase in CAS concentration for either any constant APP concentration in the bilayer assemblies. The lower values of thermal conductivities and thermal effusivities were attributed to the formation of a greater amount of thicker, more porous, and more coherent intumescent chars. On the contrary, the residual chars of burnt fabric samples coated with low CAS concentration for either any fixed APP concentrations in bilayer assemblies depicted higher values of thermal conductivity and thermal effusivity. The relatively higher values of thermal conductivities and thermal effusivities were ascribed to the formation of a comparatively lesser amount of thinner, less porous, and less coherent intumescent chars.

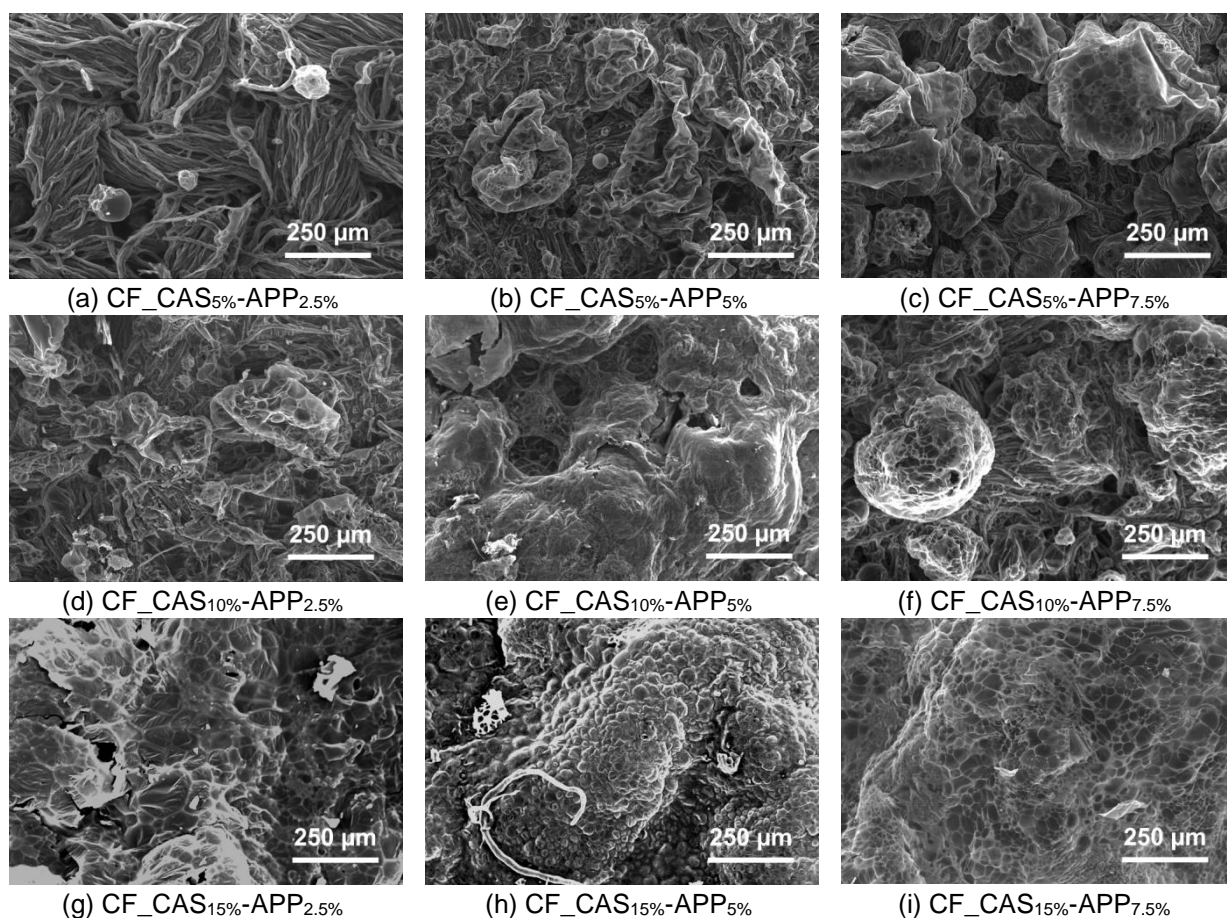

Figure 34. SEM magnifications of char residues of burnt CAS-APP bilayer coated cotton fabrics

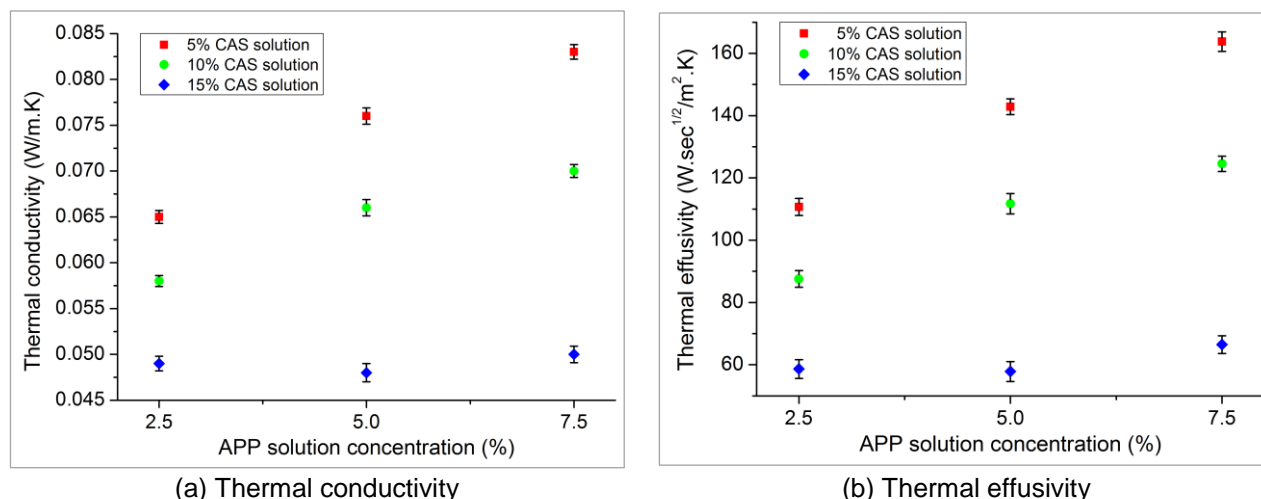

Figure 35. Heat transmission characteristics of char residues of burnt CAS-APP bilayer coated cotton fabrics

5.3.5 Radiant heat resistance

The thermal performance of uncoated and CAS-APP bilayer coated cotton fabrics, as thermal resistance and/or protection against radiant heat, was estimated by exposing the cotton fabric samples to a radiant heat source at the specified incident heat flux density (Q_0). The rise of temperature was computed at the back of fabric samples by a calorimeter, which resulted in; two threshold times (namely radiant heat transfer indexes), i.e., time for the rise of 12°C ($RHTI_{12}$) and time for the rise of 24°C ($RHTI_{24}$), transmitted heat flux density (Q_c) and heat transmission factor (TFQ_0), as listed in Table 16. The lower values of Q_c were noted for cotton fabric samples coated with CAS-APP bilayer assemblies as compared to that uncoated cotton fabric. Correspondingly, an equivalent pattern was perceived in TFQ_0 values, dropping from 57.8% to 35.1% for the cotton fabric samples bilayer coated with different concentrations of CAS and APP. The reduction in Q_c and TFQ_0 was due to an increase in the values of $RHTI_{12}$ and $RHTI_{24}$ indexes and their difference ($RHTI_{24} - RHTI_{12}$).

Table 16. Radiant heat resistance parameters of uncoated and CAS-APP bilayer coated fabrics

Sample	Q_0 (kW/m ²)	$RHTI_{12}$ (sec)	$RHTI_{24}$ (sec)	$RHTI_{24}-RHTI_{12}$ (sec)	Q_c (kW/m ²)	TFQ_0 (%)
CF_uncoated	40	3.8±0.04	6.7±0.05	2.9±0.04	23.10±0.37	57.76±0.92
CF_CAS5%-APP2.5%	40	6.1±0.05	9.6±0.04	3.5±0.04	19.12±0.25	47.80±0.63
CF_CAS5%-APP5%	40	6.4±0.07	10.1±0.09	3.7±0.05	18.18±0.27	45.45±0.68
CF_CAS5%-APP7.5%	40	6.6±0.04	10.5±0.04	3.9±0.07	17.06±0.31	42.66±0.77
CF_CAS10%-APP2.5%	40	6.5±0.08	10.3±0.05	3.8±0.04	17.60±0.21	44.01±0.53
CF_CAS10%-APP5%	40	6.7±0.07	10.7±0.05	4.0±0.05	16.47±0.22	41.17±0.56
CF_CAS10%-APP7.5%	40	7.0±0.05	11.2±0.09	4.2±0.04	15.55±0.16	38.86±0.41
CF_CAS15%-APP2.5%	40	6.9±0.08	11.0±0.05	4.1±0.05	15.99±0.21	39.99±0.53
CF_CAS15%-APP5%	40	7.3±0.07	11.7±0.08	4.4±0.08	15.06±0.29	37.64±0.72
CF_CAS15%-APP7.5%	40	7.7±0.04	12.4±0.04	4.7±0.09	14.04±0.26	35.10±0.65

The higher values of radiant heat transmission indexes and their difference, for the cotton fabrics coated with the different compositions of CAS-APP bilayer assemblies, as compared to the uncoated cotton fabric, emphasized that the temperature rise over time happened at a lower rate, signifying the delayed exchange of radiant heat towards calorimeter, i.e., the slower transmission of radiant heat. The increased values of $RHTI_{12}$, $RHTI_{24}$, and ($RHTI_{24} - RHTI_{12}$) indexes were assigned to the thicker bilayer coatings due to the higher add-on of the different compositions of CAS-APP assemblies [37–39], blocking of the spaces/interstices between the cotton fibers and yarns as verified from the SEM micrographs (see Figure 30). These larger values of ($RHTI_{24} - RHTI_{12}$) for CAS-APP bilayer coated fabric samples were recognized for the reason that the infrared radiations which performed a germane part in the heat transference were also absorbed by CAS-APP bilayer coatings of different compositions. Due to this, these CAS-APP bilayer coatings provided improved thermal resistance and insulation. That might be helpful to prevent the wearer from acquiring burn injuries. Synchronously, a reduction in the value of transmitted heat flux density, i.e., the lower quantity of transmitted radiant heat, is also deemed advantageous for the textile substrate,

resulting in its later on slower burning, as also revealed from the flammability test results of CAS-APP bilayer coated cotton fabrics (see Table 15). More precisely, it was deduced that the resistance of CAS-APP bilayer coatings to a radiant heat flux could also intensely reduce the time to ignition of bilayer coated fabrics as compared to the uncoated cotton fabric. This was attributed to the degradation/decomposition of casein and ammonium polyphosphate to release phosphoric acid exerting a deleterious effect that sensitizes the early ignition of cotton fabric and favors the cellulose dehydration to yield more thermally stable char residues instead of volatile release [32, 86]. This detrimental effect by intuition, and additionally, the catalyzed charring of casein and cotton cellulose in the presence of ammonium polyphosphate, could be extremely favorable to produce more char residues with an intumescence phenomenon, as a protective layer in advance at early thermal degradation stages, resulting in ineffective combustion of cotton due to constricted diffusion of oxygen into pyrolysis zone and also inhibiting further release of volatile species at higher temperatures [87, 88].

5.4 Flame retardant and intumescent char formation potentials of casein and polyvinyl alcohol based bicomponent composite nanoparticles coated cotton fabrics

5.4.1 Surface chemical structure

The chemical/molecular structure, of cotton fabric (CF) samples, was inspected by the ATR-FTIR spectroscopy to confirm the competence of different composition electro spray coatings and the existence of CAS and PVA on the cotton fabrics. The ATR-FTIR spectra, of uncoated cotton fabric and cotton fabric samples electro spray coated with CAS/PVA blended solutions of different compositions, are given in Figure 36. Apart from the typical vibration modes of cellulose viz. $\nu(\text{OH})$ at ca. ~ 3300 , $\nu(\text{CH}_2)$ at ~ 2900 , $\delta(\text{OH})$ at ~ 1640 , $\delta(\text{CH}_2)$ at ~ 1425 , $\delta(\text{CH})$ at ~ 1370 , $\delta(\text{OH})$ at ~ 1310 , $\nu(\text{C}-\text{C})$ at ~ 1020 , $\nu(\text{OH})$ at ~ 894 cm^{-1} , etc. [27], the electro spray coated cotton fabrics showed the additional peaks for the presence of CAS and PVA. As, the characteristics bands, in infrared spectra for proteins and polypeptides, include amide I (due to the stretching vibrations of $\text{C}=\text{O}$) and amide II (due to the bending vibrations of $\text{N}-\text{H}$) bands, resulting from the amide bonds that connect the amino acids. Therefore, the two other peaks, situated at 1624 and 1528 cm^{-1} , were substantially attributed to the respective vibrations of amide I and amide II groups of casein [28]. Whereas, a broader band observed around 3340 cm^{-1} and a peak at 1096 cm^{-1} were credited to the stretching vibration of ($-\text{OH}$) (due to the inter- and intra- hydrogen bonding) and ($\text{C}-\text{O}$) of PVA respectively. The vibration band observed at 2942 and 2910 cm^{-1} were linked to the stretching ($\text{C}-\text{H}$) from alkyl groups and the peaks at 1735 and 1245 cm^{-1} due to the stretching ($\text{C}=\text{O}$) and ($\text{C}-\text{O}-\text{C}$) from the remaining acetate groups [89]. The shifting of the abovementioned peaks/bands depicted the hydrogen bond interactions between the functional groups of cotton cellulose, casein protein, and polyvinyl alcohol polymers. Furthermore, an increase and/or a decrease in the intensity/height of the peaks indicated the deposition of higher and/or lower amounts of CAS and PVA in the form of CAS/PVA nanoparticles on cotton fabrics electro spray coated with CAS/PVA blended solutions of different compositions, which was also demonstrated by the spectra of these cotton fabrics showing the weak characteristic signals of cellulose.

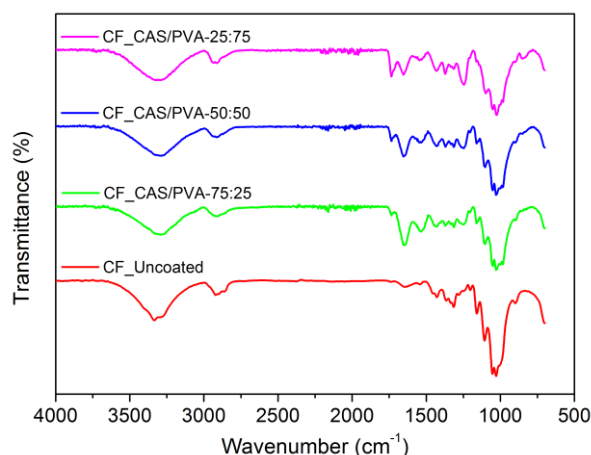

Figure 36. ATR-FTIR spectra of uncoated and CAS/PVA electro spray coated cotton fabrics

5.4.2 Surface morphology

The scanning electron microscopy generated information referring to the morphology of CAS/PVA electro spray coated cotton fabric samples. The distinctive SEM images of cotton fabrics electro spray coated with CAS/PVA blended solutions of different compositions are shown in Figure 37. It was revealed from the SEM images that the uniform distribution of CAS/PVA nanoparticles as very fine layers/coatings, on the surface of cotton fabrics, was achieved through the electro spraying coating technique. A continuous, homogeneous, and coherent coating of CAS/PVA nanoparticles was clearly observed on the fibers/yarns of electro spray coated cotton fabric samples with CAS/PVA blended solutions of different compositions.

The CAS/PVA nanoparticles presented better compatibility with cotton fibers as was verified by the absence of voids/cracks on surface coatings. Moreover, the CAS/PVA nanoparticles coated cotton fabric samples exhibited distinct individual cotton fibers, without blocking inter- and/or intra- fiber and/or yarn spaces/pores. This was an indication of probable, a less stiffening of fabrics' structure, and thus, a lower deterioration in the wearing comfort and mechanical properties of cotton fabrics after electro spray coatings. Additionally, the SEM images were also precisely observed and analyzed on "Image J" software, to measure average particle size. The homogeneity/shape-regularity and the average size of CAS/PVA nanoparticles was found to increase with an increase in the ratio/amount of PVA [90].

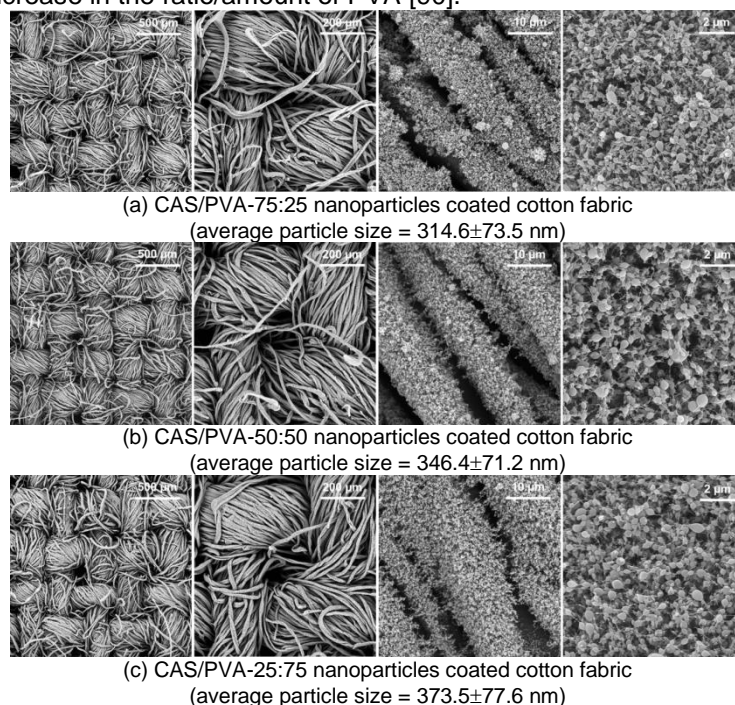

Figure 37. SEM images of CAS/PVA electro spray coated cotton fabrics

5.4.3 Thermo-oxidative stability

The thermogravimetric analysis was conducted to determine the effect of CAS/PVA nanoparticles' coatings on the thermo-oxidative stability of cotton fabrics. The plots of TG and DTG curves of all fabric samples were charted, as shown in Figure 38, which represents the weight loss and weight loss rate with an increase in the temperature. The wide range of characteristics data acquired from the testing results were also wrapped up, as given in Table 17, which presents the different decomposition temperatures and residue percentages of uncoated and CAS/PVA nanoparticles coated cotton fabric samples. All fabric samples indicated an initial mass loss in the ~50-150°C region that was imputable to the evaporation of free/residual water contained by the cotton and casein protein and polyvinyl alcohol polymers. In fact, the pure proteins generally flinch to decompose at low temperatures ~100°C to lose the water [31], accompanying to produce oligopeptides and amino acids that bear carboxylic groups and possess the ability to catalyze the decomposition of cellulose. It can be noticed that the thermal degradation of all samples consists of two steps, i.e., 200-400°C and 400-600°C. The decomposition of uncoated cotton fabric was started at 298°C and then the maximum weight loss rate (T_{max1}) was observed at 343°C in the first degradation step. The residue percentage after the first degradation step at T_{max1} was attributed to the formation of a thermally stable form of aliphatic char due to the depolymerization and dehydration of cellulose. Nevertheless, on a further increase of temperature, the second maximum weight loss rate appeared at 492°C (T_{max2}) during the second degradation step, which corresponded to the carbonization of aliphatic char into aromatic char and then further oxidation into carbon mono and dioxide [30].

Table 17. Thermo-oxidative stability data of uncoated and CAS/PVA electro spray coated cotton fabrics

Sample	$T_{onset10\%}$ (°C)	T_{max1} (°C)	T_{max2} (°C)	Residue at		
				T_{max1} (wt. %)	T_{max2} (wt. %)	600°C (wt. %)
CF_uncoated	320.11±0.51	343.33±0.23	492.17±0.45	48.1±0.3	11.3±0.4	2.3±0.3
CF_CAS/PVA-25:75	311.67±0.64	355.65±0.31	523.25±0.57	50.3±0.5	16.2±0.3	8.9±0.4
CF_CAS/PVA-50:50	308.18±0.73	352.40±0.27	530.13±0.65	52.8±0.4	18.5±0.4	11.1±0.3
CF_CAS/PVA-75:25	304.61±0.59	348.49±0.34	537.83±0.71	55.5±0.5	21.1±0.4	13.4±0.5

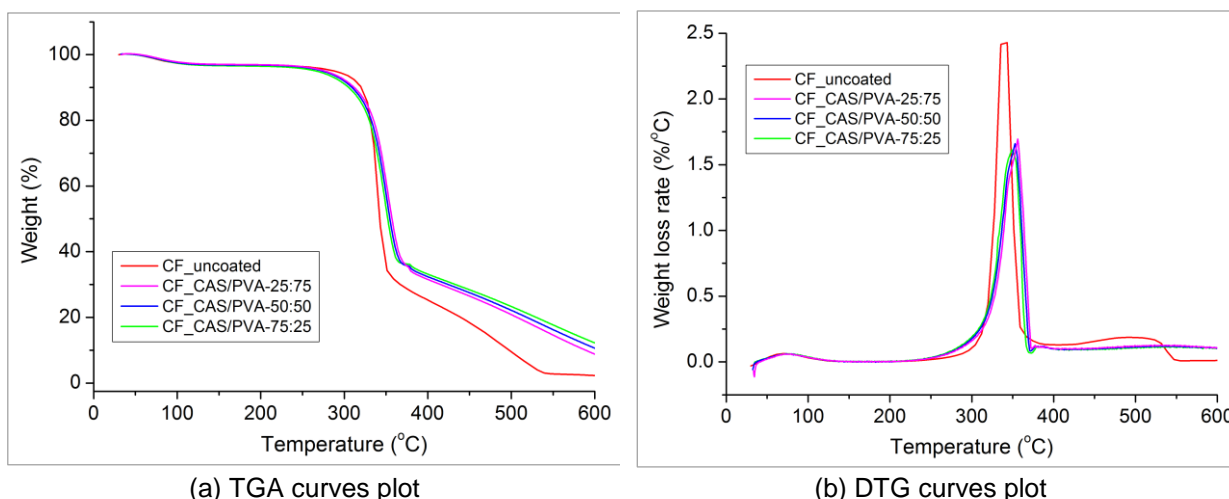

Figure 38. Thermo-oxidative stability of uncoated and CAS/PVA electro-spray coated cotton fabrics

The $T_{\text{onset}10\%}$ values of cotton fabric samples were noted to shift towards the lower temperatures when coated with CAS/PVA nanoparticles of different compositions. The effect was observed more prominent in shifting the $T_{\text{onset}10\%}$ value for the CAS/PVA electro-spray coated fabric sample containing CAS/PVA nanoparticles with a higher amount of CAS with respect to PVA. This indicated a stronger performance of casein for sensitization of the cellulose decomposition as compared to polyvinyl alcohol. In spite of these findings, the initial decomposition temperature ($T_{\text{max}1}$), of cotton fabric samples coated with CAS/PVA nanoparticles of different compositions, was also changed and described to shift toward the higher temperatures as compared to that of uncoated cotton fabric. This phenomenon was related to the reason that when PVA is heated, above decomposition temperature, it commences a quick chain stripping and elimination of water. This process, couples with melting, causes the material, to foam or intumesce as it decomposes, to yield insoluble rigid foam-like residues [91].

Therefore, in the first stage, the thermal degradation of cellulose and polyvinyl alcohol also resulted in; producing the polyene structures through dehydration, as well as, forming the three-dimensional crosslinked structures by degradation products of cellulose and polyvinyl alcohol via conjugated bond formation [92, 93]. Such crosslinked structures (in the form of foam or intumesce) enveloped the cotton fibers/yarns and showed enhanced thermal stability by preventing the degradation/decomposition of cotton fabrics, causing the shift of degradation temperatures to higher ones [93]. Most of these polyene structures also served as intermediate species and were further reacted/degraded into other lower molecular weight products in the next degradation step $T_{\text{max}2}$ to form residues as char [91, 94]. In the thermal degradation process, these crosslinked structures are usually formed and destroyed simultaneously. The percentage of residue at $T_{\text{max}2}$ and 600°C was found to increase for the CAS/PVA electro-spray coated cotton fabrics, but higher for the CAS/PVA electro-spray coated fabric sample containing CAS/PVA nanoparticles with a greater amount of CAS with respect to PVA. This compartment was imputed to the dehydration of glycosyl units of the cotton cellulose due to the release of acidic species such as phosphoric acids from the casein macromolecules [31, 95]. The fabric sample electro-spray coated with nanoparticles from CAS/PVA-75:25 blended solution compositions produced a maximum of 13.4% residue at 600°C as compared to that of 2.3% of uncoated cotton fabric.

5.4.4 Flame retardancy

The effect of different composition CAS/PVA nanoparticles' coatings on the flame retardancy of cotton fabrics was evaluated through flammability tests, i.e., limiting oxygen index (LOI) and horizontal configuration flame spread tests. The LOI value of 18.3% was obtained for the uncoated cotton fabric. Nonetheless, the LOI values were recognized to improve notably with the increased amount of CAS with respect to PVA, for the cotton fabric samples electro-spray coated with the different compositions of CAS/PVA blended solutions, as given in Table 18. This was accredited to the enhanced char residue yields of electro-spray coated cotton fabrics owing to the higher deposited phosphorous content (see Figure 39) [35, 68, 96], as also revealed from the TGA results provided in Table 17, which acted as an effective thermal insulating barrier to hinder the transfer of heat and fuel and stop the combustion process. In general, an increased LOI value usually results in lower combustibility and better flame-retardant properties of any polymeric materials including textile materials/substrates [34, 35], which was evidenced from the horizontal flame test results such as; the total burning time, burn rate and char residues of uncoated and CAS/PVA nanoparticles coated cotton fabrics, as presented in Table 18. These observed different parameters were then used to appraise the resistance for flame propagation. When a methane flame was applied for the specified time, it was noted that the uncoated cotton fabric expressed fast combustion and burnt vigorously. It was completely burnt, leaving behind a negligible amount of char residue. Contrarily, the coatings of

CAS/PVA nanoparticles on cotton fabrics were observed to facilitate an increase in total burning time, thus exhibiting their ability for flame protection. The electro-spray coated samples burnt at a slower rate and resulted in stronger char residues while preserving the original structure of the fabrics. Furthermore, the produced char exerted a protective effect on the underlying cotton fabric, limiting the oxygen diffusion, avoiding the formation of combustible volatile products, and absorbing the heat evolved during the combustion. The increase of total burning time and decrease in burn rate, as well as, consistent final char residues was noticed for the CAS/PVA nanoparticles coated cotton fabric samples as compared to that of uncoated cotton fabric, as validated from the flame retardant characteristics results given in Table 18. The 14% increase in total burning time, as well as, 33.7% final residue was found for the fabric sample electro-spray coated with nanoparticles from CAS/PVA-75:25 blended solution compositions.

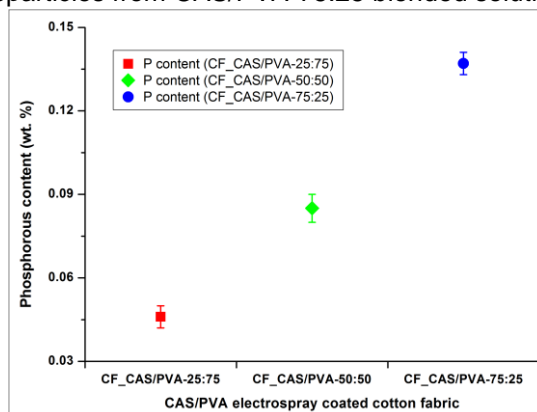

Figure 39. Phosphorous content of CAS/PVA electro-spray coated cotton fabrics

On the whole, it can be deduced that the casein contributed to improving both the flame suppression and char formation, while, the polyvinyl alcohol assisted more in thermal stability at early stages of fire pyrolysis by diluting the flame and improving the char formation at high temperature (as also evident from the TGA results) of CAS/PVA nanoparticles coated cotton fabrics. However, the flame retardant effectiveness of casein macromolecules was accredited to the phosphate groups located on the shell of casein micelles. These phosphate groups, upon heating, release phosphoric acids that favor the degradation of cellulose towards the formation of a stable char, through dehydration instead of depolymerization [31, 32]. Whereas, the char formation effectiveness of polyvinyl alcohol was attributed to some fundamental condensed phase processes during its fire like pyrolysis. These processes involve the chain-stripping elimination of water and chain-scission reactions, which take place during its pyrolysis and lead to char formation [91, 94, 97].

Table 18. Flammability characteristics of uncoated and CAS/PVA electro-spray coated cotton fabrics

Sample	LOI (vol. %)	Total burning time (s)	Burn rate (mm/s)	Char residue (%)
CF_uncoated	18.28±0.22	36.21±0.25	3.63±0.04	3.1±1.1
CF_CAS/PVA-25:75	19.11±0.27	38.13±0.31	3.37±0.03	14.8±1.7
CF_CAS/PVA-50:50	20.05±0.30	39.54±0.27	3.17±0.04	24.1±2.1
CF_CAS/PVA-75:25	21.13±0.25	41.25±0.33	2.95±0.05	33.7±1.8

The dynamics of flame propagation were also calculated using the image analysis technique. It was conducted to identify the changes in burn length and burn area over small intervals of time. The effect of different composition CAS/PVA nanoparticles' coatings on the flame propagation dynamics (i.e., burn length and burn area) of cotton fabrics can be perceived from Figure 40(a), (b). Rendering to this assay, the burn length and burn area plotted curves for the CAS/PVA electro-spray coated cotton fabric samples demonstrated a lesser steepness as compared to that for uncoated cotton fabric. Furthermore, the steepness of curves was also observed to decrease with an increase in CAS contents with respect to PVA contents. From these results, it was endorsed, a slow propagation/spread of the flame for the CAS/PVA nanoparticles coated fabrics and an improvement in self-extinguishing properties could be perceived for the cotton fabrics electro-spray coated with higher CAS contents. The fabric sample electro-spray coated with nanoparticles from CAS/PVA blended solution compositions containing a greater amount of CAS with respect to PVA exhibited about lower burn length and lower burn area value as compared to the uncoated cotton fabric as well as to those electro-spray coated with nanoparticles from CAS/PVA blended solution compositions containing a lower amount of CAS with respect to PVA. This was further verified from the photographs of carbonized areas of all fabric samples as shown in Figure 41, which were taken after 10, 20, 30, and 40 seconds of the burning time.

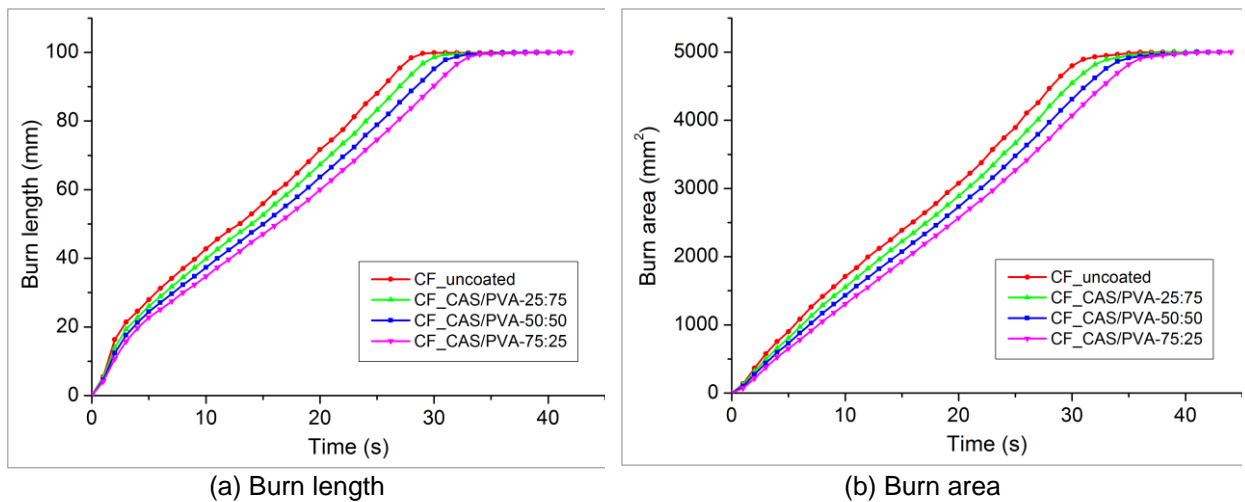

Figure 40. Plots for estimation of flame propagation with time from image analysis data

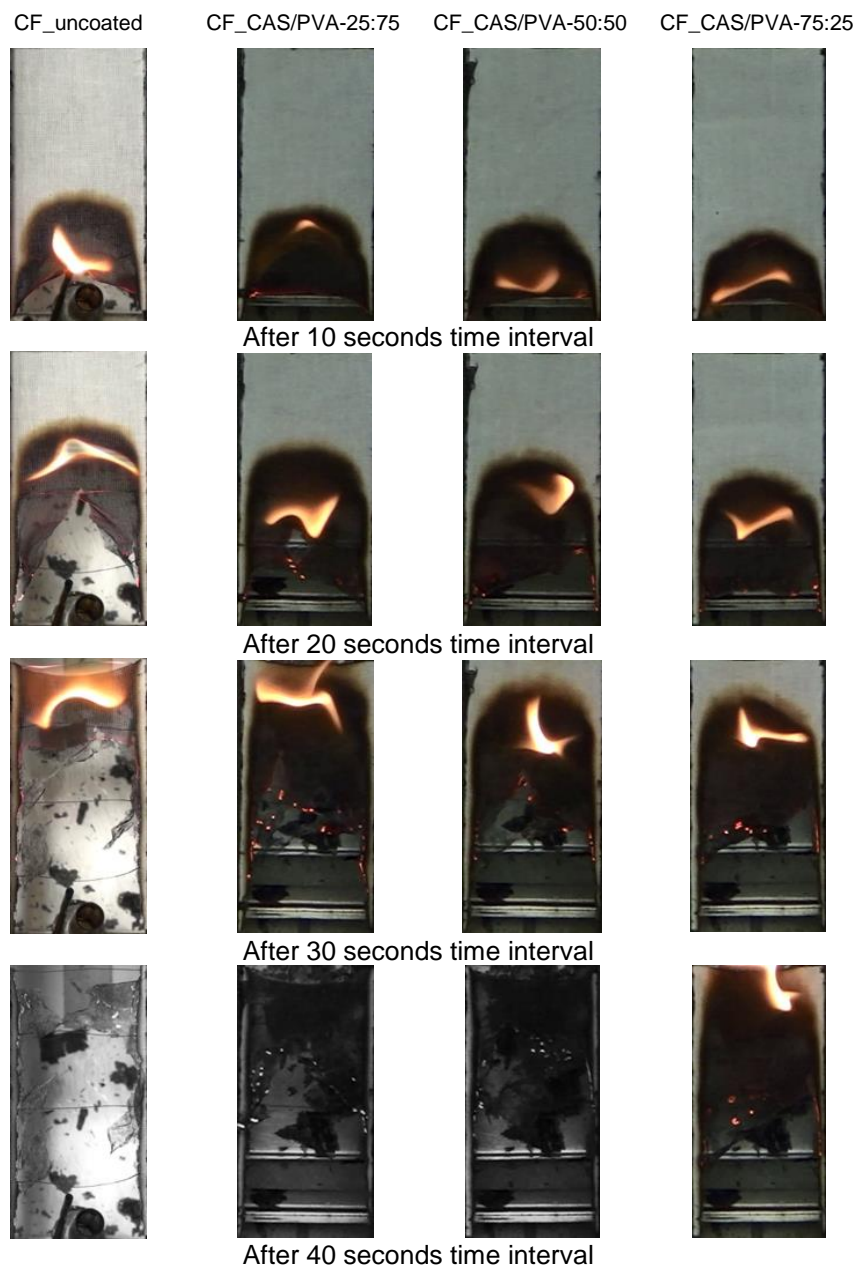

Figure 41. Photographs of burnt uncoated and CAS/PVA electro spray coated cotton fabrics at different time intervals during flame test

Thenceforth, the morphology of char residues, of burnt CAS/PVA electro spray coated cotton fabrics after the flammability test, was also reconnoitered through scanning electron microscopy, which can be observed from the SEM images as given in Figure 42. It revealed the preservation of the original structure of all the burnt CAS/PVA electro spray coated cotton fabric samples in the form of stable and consistent char, which was corroborated by the SEM images. A higher amount of mechanically strong and coherent char was observed for the burnt samples of cotton fabrics electro spray coated with CAS/PVA nanoparticles of different compositions. The morphology of char residues showed the formation of globular micrometric structures at localized spaces. Therewithal, the char residues of cotton fabric electro spray coated with CAS/PVA blended solution containing higher casein contents indicated the formation of more globular micrometric structures (i.e., local intumescence). The globular micrometric structures are phosphorus-rich bubbles that blow up during combustion [32]. The occurrence of bubbles in the residues was attributed to the evolution of ammonia, released by the casein macromolecules upon heating [31, 36].

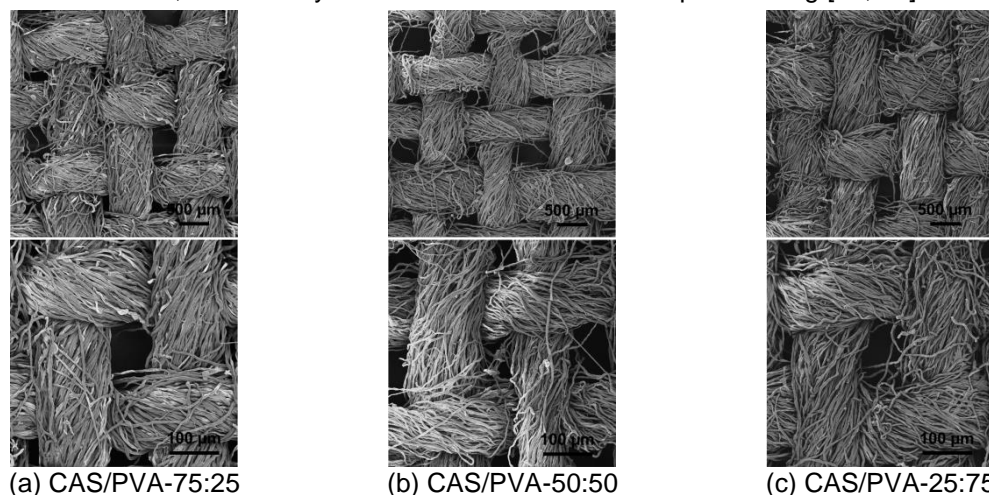

Figure 42. SEM magnifications of char residues from burnt CAS/PVA electro spray coated cotton fabrics

5.4.5 Radiant heat resistance

The thermal protection demeanor of uncoated and CAS/PVA electro spray coated cotton fabrics, as thermal resistance and/or protection against radiant heat, was estimated by exposing the cotton fabric samples to a radiant heat source at the specified incident heat flux density (Q_0). The rise of temperature was computed at the back of fabric samples by a calorimeter, which resulted in; two threshold times (namely radiant heat transfer indexes), i.e., time for the rise of 12°C (RHTI_{12}) and time for the rise of 24°C (RHTI_{24}), transmitted heat flux density (Q_c) and heat transmission factor (TFQ_0), as listed in Table 19. A drop in Q_c values was discerned for cotton fabric samples coated with CAS/PVA nanoparticles of different compositions as compared to that of uncoated cotton fabric. Subsequently, a similar pattern was perceived in TFQ_0 values, dropping from 57.8% to 49.2% for the cotton fabric samples electro spray coated with the different compositions of CAS/PVA blended solutions.

Table 19. Radiant heat resistance parameters of uncoated and CAS/PVA electro spray coated cotton fabrics

Sample	Q_0 (kW/m^2)	RHTI_{12} (sec)	RHTI_{24} (sec)	$\text{RHTI}_{24}-\text{RHTI}_{12}$ (sec)	Q_c (kW/m^2)	TFQ_0 (%)
Uncoated	40	3.8 ± 0.04	6.7 ± 0.05	2.9 ± 0.04	23.10 ± 0.37	57.76 ± 0.92
CAS/PVA-25:75	40	4.3 ± 0.05	7.7 ± 0.04	3.3 ± 0.05	19.92 ± 0.32	49.81 ± 0.81
CAS/PVA-50:50	40	4.4 ± 0.07	7.8 ± 0.05	3.4 ± 0.05	19.80 ± 0.31	49.53 ± 0.80
CAS/PVA-75:25	40	4.5 ± 0.07	7.9 ± 0.04	3.5 ± 0.04	19.69 ± 0.27	49.21 ± 0.66

The reduction in Q_c and TFQ_0 was due to an increase in the values of RHTI_{12} and RHTI_{24} indexes and their difference ($\text{RHTI}_{24} - \text{RHTI}_{12}$). The higher values of radiant heat transmission indexes and their difference, for the cotton fabrics coated with CAS/PVA nanoparticles of different compositions, as compared to the uncoated cotton fabric, accentuated that the temperature rise with reference time resulted in a lower rate, specifying the deferred exchange of radiant heat towards calorimeter, i.e., the slower transmission of radiant heat. The increased values of RHTI_{12} , RHTI_{24} , and ($\text{RHTI}_{24} - \text{RHTI}_{12}$) indexes were apportioned to the CAS/PVA nanoparticles' coatings//layers of different compositions [98, 99], causing to covering partially and/or reducing, as well as, homogenizing the sizes of larger interstices (i.e., spaces and/or voids) between the cotton fibers and yarns as confirmed from the SEM micrographs (see Figure 37). These larger values of ($\text{RHTI}_{24} - \text{RHTI}_{12}$) for the CAS/PVA electro spray coated fabric samples were indorsed for the reason that

the infrared radiations which performed an apropos part in the heat transference were also absorbed by the CAS/PVA nanoparticles' coatings/layers. Due to this the CAS/PVA nanoparticles' coatings/layers provided improved thermal resistance and insulation. That might be helpful to prevent the wearer from acquiring burn injuries. Concomitantly, a reduction in the value of transmitted heat flux density, i.e., the lower quantity of transmitted radiant heat, is also reckoned valuable for the textile substrate, resulting in its later on slower burning, as also revealed from the flammability test results of CAS/PVA electro spray coated cotton fabrics (see Table 18). More correctly, it was reasoned that the resistance of CAS/PVA nanoparticles' coatings/layers to a radiant heat flux could also radically reduce the time to ignition of electro spray coated fabrics as compared to the uncoated cotton fabric. This can be credited to the degradation/decomposition of casein to release phosphoric acid exerting a deleterious effect that sensitizes the early ignition of cotton fabric, and favors the cellulose dehydration to yield more char residues instead of volatile release [32]. This detrimental effect by perception, as well as, the three-dimensional crosslinked structures (in the form of foam or intumesce) formed by thermal degradation products of cellulose and polyvinyl alcohol, could be enormously beneficial to produce more char residues [92, 93], as a protective layer in advance at early thermal degradation stages, resulting in ineffective combustion due to the restricted diffusion of oxygen into the pyrolysis zone and also inhibiting the further release of volatile species at higher temperatures.

5.4.6 Physiological comfort and mechanical properties

The air permeability, water vapor permeability, thermal conductivity, stiffness/bending rigidity, tensile and tear testing, of uncoated and CAS/PVA electro spray coated cotton fabrics, was executed to determine properties connected with physiological comfort and mechanical performance, as discussed in the following sections.

Air permeability

Figure 43(a) shows the effect of CAS/PVA nanoparticles' coatings, electro sprayed from blended solutions of different compositions, on the air permeability of cotton fabrics. The air permeability of uncoated cotton fabric was quantified $\sim 620.05 \text{ l.m}^{-2}.\text{s}^{-1}$. However, it can be seen that there is no substantial drop in the air permeability of CAS/PVA electro spray coated cotton fabrics. This behavior was explicated by the formation of CAS/PVA nanoparticles' coatings on the surface of cotton fabric samples, which partially covered the interspaces between the fibers and yarns, unlike the other traditional coating methods [100, 101]. A little obstruction in airflow through these fabrics was accredited to, the reduced size of inter-fiber and inter-yarn spaces/pores by the coatings of CAS/PVA nanoparticles [102, 103].

Water vapor permeability

Figure 43(a) shows the effect of CAS/PVA nanoparticles' coatings, electro sprayed from blended solutions of different compositions, on the relative water vapor permeability of cotton fabrics. The relative water vapor permeability of uncoated cotton fabric was quantified $\sim 77.04 \%$. As well, the air permeability, an analogous trend of CAS/PVA nanoparticles' coatings, was also noticed for the water vapor permeability. The moisture vapor transport properties of cotton fabrics were less affected after that of the CAS/PVA electro spray coatings [100, 104]. A slight loss of moisture vapor transport, for the cotton fabrics electro spray coated with CAS/PVA nanoparticles from the blended solutions of different compositions, was conceded due to; the deposited CAS/PVA nanoparticles' coatings/layers on the surface of cotton fabric samples, and eventually partial closing or minimizing the size of inter-fiber and intra-yarn spaces [102, 105].

Thermal conductivity

Figure 43(a) shows the effect of CAS/PVA nanoparticles' coatings, electro sprayed from blended solutions of different compositions, on the thermal conductivity of cotton fabrics. The thermal conductivity of uncoated cotton fabric was quantified $\sim 45.42 \times 10^{-3} \text{ W.m}^{-1}.\text{K}^{-1}$. It was analyzed a reduction in the thermal conductivity of CAS/PVA electro spray coated cotton fabrics. This compartment was elucidated by the deposition of CAS/PVA nanoparticles' coatings/layers on the surface of cotton fabric samples [99], ultimately partially blocking the interspaces between the fibers and yarns. As, the nanoparticles' coatings/layers typically possess a higher surface area to volume ratio, ensuing a highly porous structure [106]. Perhaps, in addition to the effect of partial covering the interspaces between the fibers and yarns by CAS/PVA nanoparticles' coatings/layers, a reduction in the thermal conductivity, of CAS/PVA electro spray coated cotton fabrics, might be due to the supplemental contribution and/or the effect of the entrapped air inside the characteristic pores of the coating/layer structure of CAS/PVA nanoparticle [100, 105].

Stiffness

Figure 43(b) shows the effect of CAS/PVA nanoparticles' coatings, electro sprayed from blended solutions of different compositions, on the bending properties of cotton fabrics. The stiffness value of uncoated cotton fabric was quantified $\sim 5.17 \times 10^{-6} \text{ N.m}$. It was examined that the stiffness of CAS/PVA electro spray coated cotton fabric samples increased a trivial. This could be correlated with the deposition of CAS/PVA nanoparticles over the cotton fabric structure that built the links/bonds between the fibers and/or yarns due to the gluing and binding properties of casein and polyvinyl alcohol [58, 107], heightening the inter-fiber/yarn

friction at the fibers/yarns cross-over points (i.e., restraining the free movement of fibers/yarns) and letting the fabric difficult to bend [102, 103, 108].

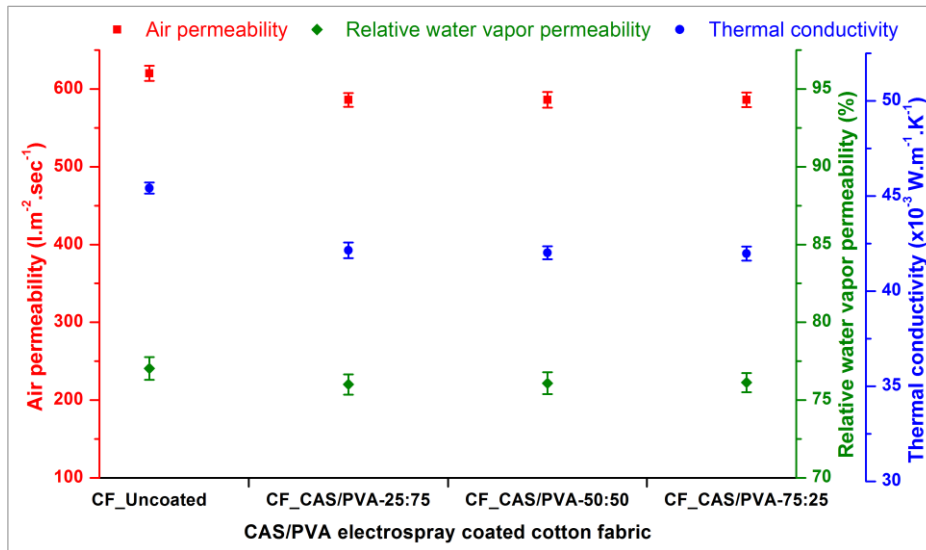

(a) Air permeability, water vapor permeability, thermal conductivity

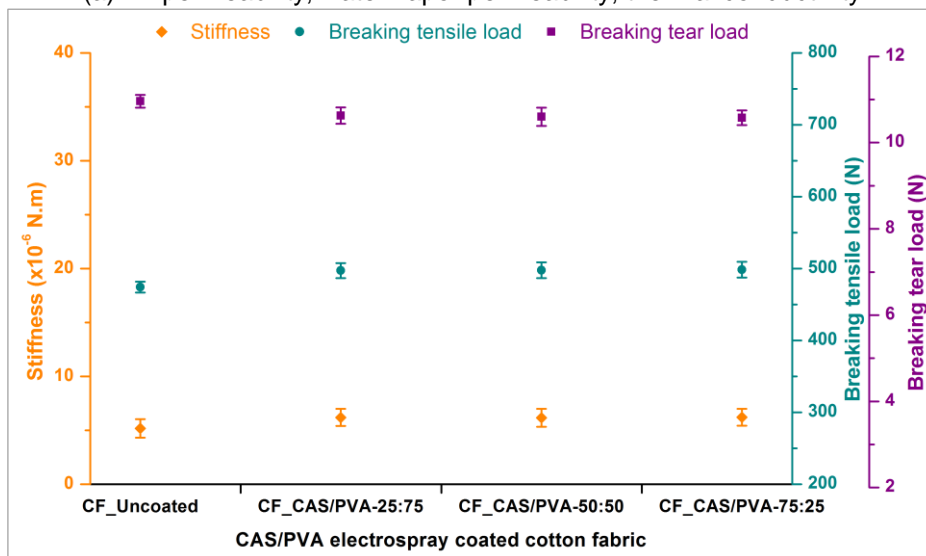

(c) Stiffness, tensile strength, tear strength

Figure 43. Comfort and mechanical properties of uncoated and CAS/PVA electrospray coated cotton fabrics

Tensile properties

Figure 43(b) shows the tensile testing results and the effect of CAS/PVA nanoparticles' coatings, electrospayed from blended solutions of different compositions, on the tensile breaking force (tensile breaking load/stress in newton) of cotton fabrics. The value of the breaking tensile load for the uncoated cotton fabric was quantified ~474.18 N. Whereas, it was ascertained that the breaking tensile load for CAS/PVA electrospray coated cotton fabrics increased marginally. The increased breaking force can be explicated by a contribution of the load-bearing capacity [109], of attached CAS/PVA nanoparticles' coatings/layers on the surfaces of fibers and yarns in the fabric structure. This can also be recognized due to the reason that the CAS/PVA nanoparticles pierce into the fabric structure during their application on the cotton fabrics through the electrospaying method. Then the CAS/PVA nanoparticles partially cover the spaces between the fibers and yarns and bind them together, causing an increase in the bending rigidity and eventually the tensile breaking load of electrospray coated fabrics [109].

Tear Properties

Figure 43(b) shows the tear testing results and the effect of CAS/PVA nanoparticles' coatings, electrospayed from blended solutions of different compositions, on the tear breaking force/tearing force (tear breaking load/stress in newton) of cotton fabrics. The value of breaking tear load for the uncoated cotton fabric was quantified ~10.96 N. Unlike the tensile testing results, it was ascertained that the tearing force for CAS/PVA electrospray coated cotton fabrics decreased slightly. The reduced tearing force can be explicated by an increase in cotton fabric rigidity after electrospray coatings of CAS/PVA nanoparticles, offering less resistance to an applied force for rupture/tearing. This can also be recognized due to the reason

that the CAS/PVA nanoparticles impale the voids between the fibers and yarns during their application on the cotton fabrics through the electrospraying method. Subsequently, the CAS/PVA nanoparticles situate in the fabric structure and intervene with fiber-to-fiber and yarn-to-yarn interactions by binding them, causing a reduction of their free movement and sliding, as well as, the flexibility of fabric structure [109]. When the yarns are bonded together at a place in the fabric structure, the tearing force applied on individual yarns one at a time, results in a lower tearing force value.

5.5 Washing durability and crosslinking of casein with cotton fabrics

The casein treatments to cotton fabrics were determined to impart flame retardancy by suppressing flame propagation. As, the cotton fabric treated with 30% casein concentration, exhibited improved flame retardant characteristics in terms of the total burning time (~48.4 s), burning rate (~2.34 mm/s), and char residue (~53.1 %) as compared to that of untreated cotton fabric. But, the casein films/layers/coatings on casein treated cotton fabrics were found not to be resistant and/or less durable to washing treatments. It was observed that these casein coatings went off in water from cotton fabrics when subjected to washing according to some specific standard test methods, instead, even in mild conditions washings; i.e., at a low temperature (30°C) for short cycles and with and/or without using any detergent. This could be due to the reason that the proteins usually bind to cotton fibers' surface through the van der Waals forces and hydrogen bonding [110]. The chemical affinity of casein protein to cotton cellulose has been considered and adduced to be associated with the interactions between the hydrogen of hydroxyl groups of cellulose and the carboxylate groups as well as the peptide bonds of amino acids of casein [111], as shown in Figure 44. In addition, the possible and propounded binding mechanism may also involve the carbohydrate- π interactions [112, 113].

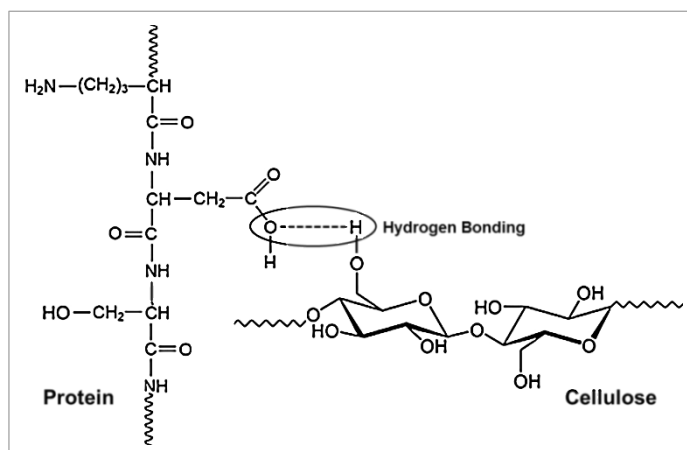

Figure 44. General mechanism of interaction between casein protein and cotton cellulose

At present, various chemical substances belonging to different classes have been studied and used, for the self-crosslinking of molecular/polymeric chains of proteins, and also for the self-crosslinking of molecular/polymeric chains of cotton cellulose fibers, ultimately improving their different special kind of properties regarding the end-use applications. But in the literature, the present research studies and works on crosslinking/binding of proteins with textile substrates are very limited, especially that of casein protein with cellulosic-based cotton fabric (to make it durable to washing) has not been well attempted and explored yet. Correspondingly, the different chemical crosslinking/binding systems were conjectured as probable for crosslinking of casein (i.e., protein) to cotton (i.e., cellulose) as an after-/post-treatment finishing process for the casein treated cotton fabrics, simultaneously emphasizing an adequate balance of green features. These different chemical crosslinking systems such as; glutaraldehyde (a dialdehyde), citric acid (a polycarboxylic acid), tannic acid (a polyphenol), Texapret LF (a resin), tetraethoxysilane (a silane), also their certain suitable and applicable application conditions were anticipated, due to their ability to react with the common functional groups present in the molecular/polymeric structure of casein and cotton. Consequently, after post-treatment finishing of 30% casein concentration treated cotton fabric samples with 5% concentration of different types of crosslinking chemical agents, all fabric samples were washed/laundered according to the standard test method in order to examine the durability of casein coatings on cotton fabrics to multiple washing/laundering cycles. For this purpose the horizontal flame test was performed, for all untreated, treated, unwashed, and washed fabric samples, at zero wash cycle (i.e., before washing) and after 1, 5, 10 & 15 wash cycles (i.e., after washing), to assess the flame retardant performance. The different variables such as the total burning time, burn rate, and final char residues, for all fabric samples, were then noted and compared, as shown in Figure 45(a), (b), (c) respectively. Though, the casein treated cotton fabric sample (i.e., without any post-treatment) was found to burn just like the untreated cotton fabric with very little char residues, even after one washing cycle. Nevertheless, it was distinctly evidenced from the obtained results that the different types of defined crosslinking systems were potentially substantiated to improve the washing durability of casein coatings on cotton fabrics. This

improved phenomenon was varied comparatively up to certain washing/laundrying cycles (see **Chyba! N enalezen zdroj odkazů.**(a), (b), (c)), relating to the chemical nature of crosslinking systems, and hence their crosslinking capability, at the specified and applied fixed concentration and application conditions.

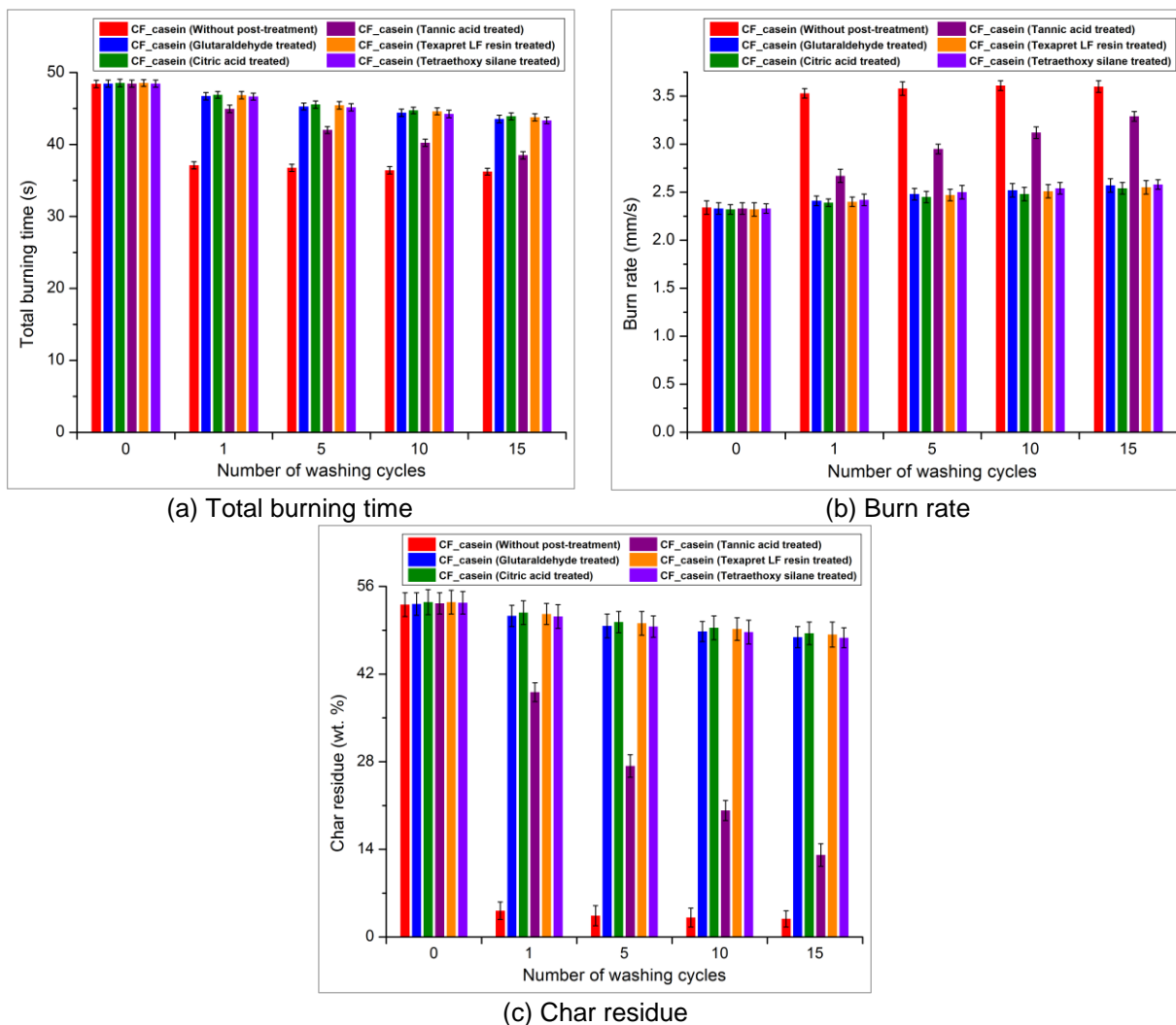

Figure 45. Flammability characteristics of casein treated cotton fabrics after post-treatment finishing and washing

The possible crosslinking mechanisms and reactions of used chemicals, for enhancing the washing durability of casein coatings on cotton fabrics, are explained following. The dialdehydes react with the hydroxyl ($-OH$) groups of cotton cellulose leading to the formation of hemiacetals/acetals through an acetylation reaction [114, 115]. Whereas, the dialdehydes react with the amino ($-NH_2$) and hydroxyl ($-OH$) groups of casein protein leading to the formation of; imine (Schiff base) through Schiff base reaction, and hemiacetal through acetylation reaction respectively, depending on the pH conditions of reaction [116, 117]. Therefore, the probable crosslinking interactions between cotton cellulose and casein protein in presence of glutaraldehyde can be considered, as illustrated in Figure 46.

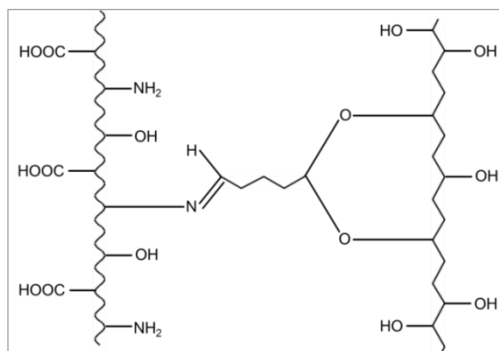

Figure 46. Schematic representation of crosslinking mechanism of casein protein with cotton cellulose using glutaraldehyde

The polycarboxylic acids form ester crosslinks with the hydroxyl (–OH) groups of cotton cellulose through an esterification reaction [118–121]. Whilst, the free amino (–NH₂) groups present in proteins undergo a nucleophilic substitution reaction with the carboxyl (–COOH) groups present in polycarboxylic acids to form a new amide linkage/bond through acylation reaction during this process [122, 123]. Therefore, the probable crosslinking interactions between cotton cellulose and casein protein in presence of citric acid can be regarded, as depicted in Figure 47.

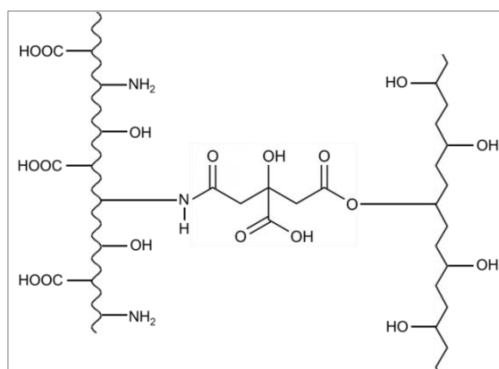

Figure 47. Schematic representation of crosslinking mechanism of casein protein with cotton cellulose using citric acid

The mechanisms of interaction between polyphenols (e.g., tannins) and macromolecules such as polysaccharides (e.g., cellulose) and/or proteins are primarily regulated by the noncovalent forces, involving the hydrogen bonding and hydrophobic interactions as well as the ionic interactions, van der Waals forces, and π - π stacking [124–131]. Withal, hydrogen bonding usually involves the polar groups of cellulose and proteins (i.e., amino, carboxyl, and hydroxyl groups) and the hydroxyl and carbonyl groups of polyphenols. While hydrophobic interactions typically comprise the nonpolar domains/regions of macromolecules and polyphenols molecules. Therefore, the probable crosslinking interactions between cotton cellulose and casein protein in presence of tannic acid can be speculated, as demonstrated in Figure 48.

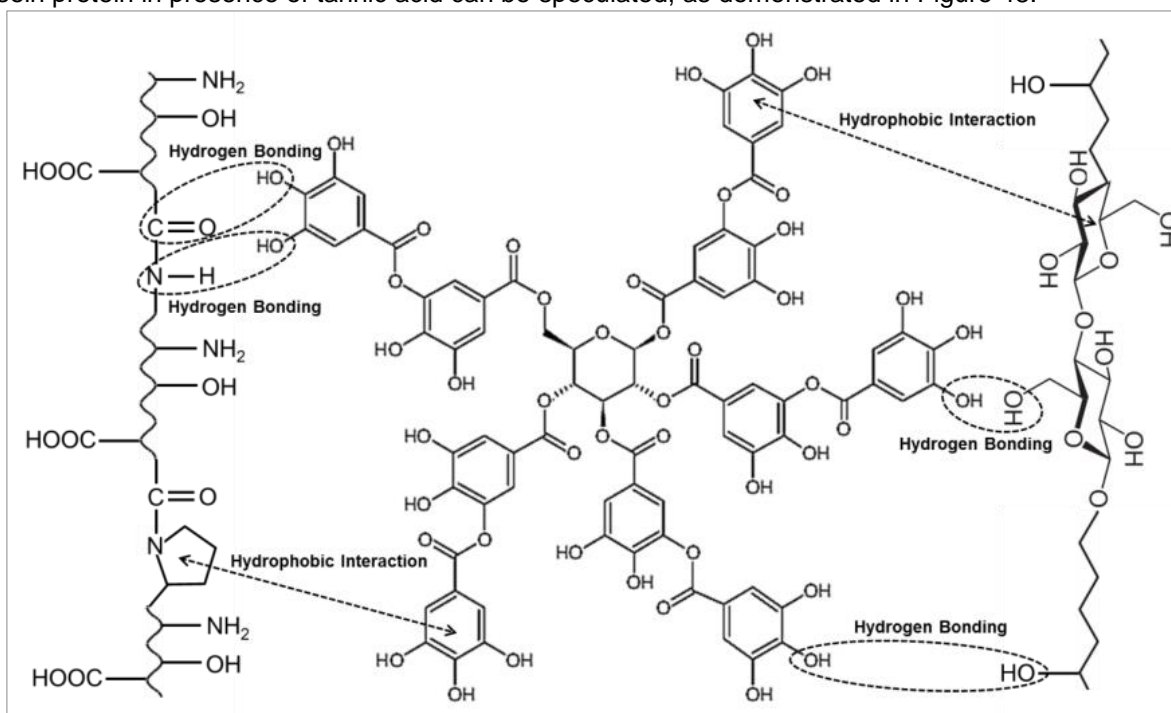

Figure 48. Schematic representation of crosslinking mechanism of casein protein with cotton cellulose using tannic acid

The principle crosslinking reaction of the N-methylol groups in DMDHEU (N,N'-dimethylol-4,5-dihydroxyethylene urea / 1,3-dimethylol-4,5-dihydroxyethylene urea) with cotton cellulose is an etherification of the hydroxyl (–OH) groups [132–136]. Despite this, the DMDHEU can react and crosslink with the casein protein through an esterification reaction between the N-methylol groups of DMDHEU and the carboxyl (–COOH) groups of casein. In addition, the chemical reaction between the N-methylol groups of DMDHEU and the amino (–NH₂) groups of casein protein is also possible [110, 137, 138]. Therefore, the probable crosslinking interactions between cotton cellulose and casein protein in presence of DMDHEU-based resin (TEXAPRET LF resin) can be figured, as exhibited in Figure 49.

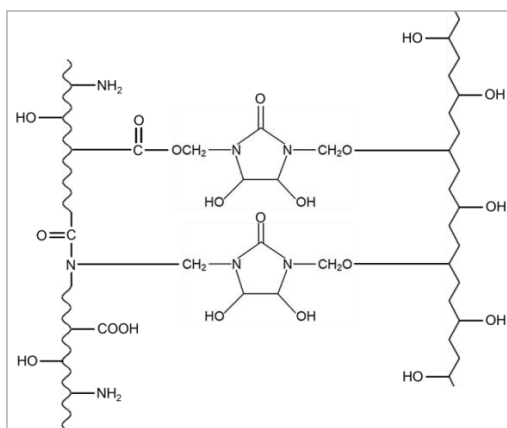

Figure 49. Schematic representation of crosslinking mechanism of casein protein with cotton cellulose using DMDHEU-based resin

The adsorption phenomenon of organosilanes/silanes (i.e., organoalkoxysilanes/alkoxysilanes) with cotton fibers ensues through the hydrogen bonding between the hydroxyl ($-OH$) groups of cellulose and the silanol ($\equiv Si-OH$) groups of prehydrolyzed alkoxysilanes first [139]. Finally, the heat treatment allows the water evaporation via a condensation reaction, which results in the formation of siloxane ($\equiv Si-O-Si \equiv$) bridges and the chemical grafting with cotton cellulose through ($\equiv Si-O-C \equiv$) covalent bonding [140–143]. Whilst, the adsorption behavior and reactivity mechanism of prehydrolyzed alkoxysilanes with proteins involve electrostatic attractions, hydrogen bonding, and hydrophobic interactions [144–146]. Then condensation reaction takes place upon heat treatment and releases water molecules in vapor form. The condensation reaction favors the generation of chemical grafting/covalent bonding ($\equiv Si-O-Si \equiv$ & $\equiv Si-O-C \equiv$) between the silanol ($\equiv Si-OH$) groups of prehydrolyzed alkoxysilanes and the hydroxyl groups ($-OH$) and carboxyl ($-COOH$) groups of casein protein [147–150]. Therefore, the probable crosslinking interactions between cotton cellulose and casein protein can be deemed in presence of tetraethoxysilane (TEOS), as exemplified in Figure 50.

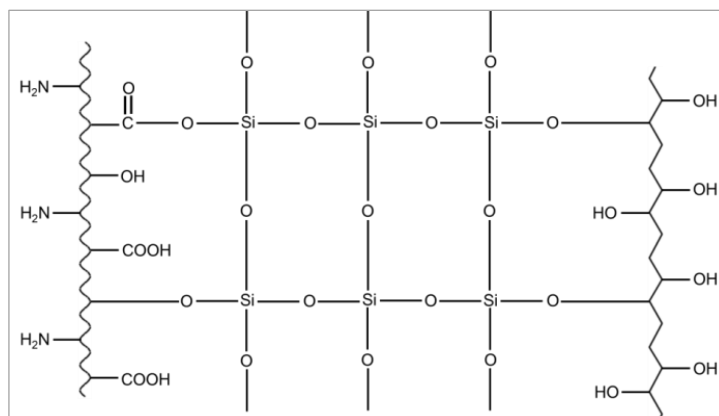

Figure 50. Schematic representation of crosslinking mechanism of casein protein with cotton cellulose using tetraethoxysilane

6 Evaluation of results and new findings

The output results data attained from characterization and testing were analyzed, interpreted, and discussed. On these bases, various significant information, interpretations, and inferences as well as considerable future viewpoints were deduced from this research work, which express its significant impacts. The overall derived findings from this research work study are as follows:

Surface structure features

- The SEM images and ATR-FTIR spectra confirmed effective application and deposition as well as the presence of films/layers/coatings of casein-alkaline/acidic, casein-ammonium polyphosphate intumescent system, and casein/polyvinyl bicomponent composite nanoparticles on cotton fabrics.
- The films/layers/coatings were continuous, homogeneous, and coherent without the existence of any voids and/or cracks indicating better compatibility of casein protein and its synergistic/hybrid systems with cotton cellulose.
- The treatments of cotton fabrics with casein coatings through traditional padding and coating methods appeared to cover more interstices and/or pores between individual fibers and/or yarns within fabric structure eventually increasing fabric stiffness as compared to that with casein-based nanoparticles coatings through modernized electro spraying technique.

Thermal characteristics and flame retardant behavior

- The thermos-oxidative stability of casein-alkaline/acidic, casein-ammonium polyphosphate, and casein/polyvinyl alcohol finished cotton fabrics were ascertained to enhance, anticipating stronger sensitization of cellulose degradation/decomposition as well as favoring the formation of higher amounts of thermally stable residues (i.e., char) depending on treatments of cotton fabrics with casein alone or casein-based synergistic/hybrid systems, as revealed by higher residue percentages at the end of thermogravimetric analyses.
- The decrease in burn rates and flame stoppage time, as well as the increase in total burning times during flame tests, vindicated delayed flame propagation/spread for cotton fabrics finished with casein-alkaline/acidic, casein-ammonium polyphosphate intumescent system, and casein/polyvinyl bicomponent composite nanoparticles, producing larger amounts of char residues as well as exhibiting intumescence effects corresponding to treatments of cotton fabrics with casein alone or casein-based synergistic/hybrid systems, as also validated by image analysis data and justified by an increase in limiting oxygen index values.
- The flame retardant performance, limiting oxygen index, char formation, and intumescence effect were obtained higher for cotton fabrics finished with acidic casein solutions as compared to that finished with alkaline casein solutions.
- An intumescent flame retardant system based on casein in combination with ammonium polyphosphate as bilayer coatings was efficaciously constituted for cotton fabrics. Casein was determined as char forming and blowing agent when applied as bilayer coatings in combination with ammonium polyphosphate on cotton fabrics that were able to generate a voluminous char functioning as a thermal shield/barrier and self-extinguish the flame.
- An intumescent char-forming system based on casein in combination with polyvinyl alcohol as bicomponent composite nanoparticles coatings was adequately contrived for cotton fabrics. Polyvinyl alcohol was perceived as a high-temperature char-forming agent when deposited as bicomponent composite nanoparticles in combinations with casein (i.e., char-forming and blowing agent) on cotton fabrics that were capable to produce intumescent char operating as a thermal barrier and retard the flame propagation.
- The thermal resistance/insulation behavior (i.e., thermal protective performance), of casein-alkaline/acidic, casein-ammonium polyphosphate, and casein/polyvinyl alcohol finished cotton fabrics, was found to improve. The transmitted heat flux density and heat transmission factor were discerned to shift towards lower values for finished cotton fabrics as compared to that of control cotton fabric manifesting as protection against radiant heat as well as enhanced thermal protection phenomenon subjecting on treatments of cotton fabrics with casein alone or casein-based synergistic/hybrid systems.

Physiological comfort and mechanical properties

- As flame retardant textile finishing comprises the loss of physiological comfort and mechanical properties of textile fabrics. It is due to the reason, that at an industrial/production scale, the flame retardant chemicals/materials/finishes are usually applied to textile fabrics through traditional padding and coating methods and generally in higher amounts to attain the desired flame retardancy level. After application on fabrics, through impregnation or coating, the flame retardant chemicals/materials/finishes penetrate and/or coat the fibers/yarns, and then bind/crosslink the fibers/yarns, resulting in the blockage of inter- and intra- fiber/yarn interstices, and consequently the loss of physiological comfort and mechanical properties.
- The treatments of cotton fabrics with casein coatings through traditional methods were evinced to forfeit their physiological comfort and mechanical properties normally at higher add-on values of casein that were typically effective to induce higher flame retardancy accompanying slower flame propagation and greater amount of intumescent char residues.
- The treatments of cotton fabrics with casein-based nanoparticles through modernized electro spraying technique were recognized to establish an adequate viable balance between their thermal characteristics and flame retardant behavior, and, physiological comfort and mechanical properties.

Washing durability performance

- The casein coatings on casein finished cotton fabrics were not resistant and/or less durable to washing treatments even in mild conditions washings; i.e., at low temperatures for short cycles and with and/or without using any detergent.
- Washing durability was effectuated through post-treatments of casein treated cotton fabrics using certain suitable less toxic and/or environmentally friendly chemical agents conforming to different crosslinking/binding systems (such as phenols, aldehydes, carboxylic acids, resins, silanes).

The essence of this research work study is the possible potential flame retardant attributes provided by the bio-treatments/bio-applications along with their safety and environmental aspects. This appears to represent a robust starting point of ecological and economic interests for the development of flame retardant alternatives, which can replace partially/fully and affirm flame/fire rendition comparable to traditional/conventional environmentally-dangerous high-performing halogen-based or phosphorus-based synthetic flame chemicals/materials/finishes for textile materials. Significant achieved results as described above have clearly demonstrated that it is possible to expatiate techno-chemical features of casein protein toward the development of efficient green and eco-friendly flame retardant systems for cotton fabrics. Correspondingly, cotton fabrics finished with casein and casein-based synergistic/hybrid systems can be utilized in apparel/clothing, home furnishings, technical textiles, etc. The potentiality of biomass-based (bio-based, i.e., biopolymers; biomacromolecules) natural products in the field of flame retardants and/or flame retardancy is quite high although almost all discussed approaches in existent literature related to the subject matter still require more deep explorations. At present, there are certain limitations related to the development of efficient flame retardants based on all biopolymers comprising casein protein. However, the possibility of adjusting these green technologies to a large scale (semi-pilot, pilot, or industrial) is still under evaluation, depending on the cost-effectiveness of biopolymers. But there is no doubt about its potential and suitability to mature and commercialize this emerging technology for imparting flame retardancy to textile substrates, which can find application in various niche areas.

Even though bio-based natural materials/products have been studied and researched considerably in the recent decade still need to be further. This does not exclude the near future exploitation of biologically derived chemical treatments, or at least, of chemicals with a low environmental impact, which could make biopolymers more effectively efficient and durable than today. The ideas, experiments, results data, and deductions generated as part of this research work study have added to the knowledge domain that could be useful to define future work directions and provide insightful references for researchers. The probable potential of this research can be realized by pursuing to conduct further studies. Further research work studies may be devoted to exploring certain possible solutions for limitations keeping in mind that an acceptable balance between green features of naturally occurring biopolymers including casein protein and the use of other thermally stable and flame retardant synergistic/hybrid chemicals/materials/products (such as metal oxide and hydroxide, metal nanoparticles, carbon and silicon nanoparticles, graphene and graphene oxide, nano clays and fillers, nanoclays, etc.) for enhancing its flame retardant features for different kind of textile fabrics as well as for textile and/or polymer composites, films, and membranes.

7 References

- [1] R. E. Lyon and M. L. Janssens, "Polymer flammability," Washington, D.C., United States. Department of Transportation. Federal Aviation Administration. Office of Aviation Research, DOT/FAA/AR-05/14, 2005.
- [2] C. K. Kundu, Z. Li, L. Song, and Y. Hu, "An overview of fire retardant treatments for synthetic textiles: From traditional approaches to recent applications," *Eur. Polym. J.*, vol. 137, p. 109911, 2020.
- [3] D. Price and A. R. Horrocks, "Polymer degradation and the matching of FR chemistry to degradation," in *Fire retardancy of polymeric materials*, 2nd ed., C. A. Wilkie and A. B. Morgan, Eds. Taylor & Francis and CRC Press, 2010, pp. 15–42.
- [4] A. B. Morgan and C. A. Wilkie, "An introduction to polymeric flame retardancy, its role in materials science, and the current state of the field," in *Fire Retardancy of Polymeric Materials*, 2nd ed., C. A. Wilkie and A. B. Morgan, Eds. Taylor & Francis and CRC Press, 2009, pp. 1–14.
- [5] R. F. Schwenker and E. Pacsu, "Chemically modifying cellulose for flame resistance," *Ind. Eng. Chem.*, vol. 50, no. 1, pp. 91–96, 1958.
- [6] F. Shafizadeh, "Pyrolysis and combustion of cellulosic materials," in *Advances in Carbohydrate Chemistry*, vol. 23, M. L. Wolfrom and R. S. Tipson, Eds. Elsevier, 1968, pp. 419–474.
- [7] A. R. Horrocks, "Developments in flame retardants for heat and fire resistant textiles-the role of char formation and intumescence," *Polym. Degrad. Stab.*, vol. 54, no. 2–3, pp. 143–154, 1996.
- [8] A. R. Horrocks, "Flame retardant challenges for textiles and fibres: New chemistry versus innovatory solutions," *Polym. Degrad. Stab.*, vol. 96, no. 3, pp. 377–392, 2011.
- [9] M. Neisius, T. Stelzig, S. Liang, and S. Gaan, "Flame retardant finishes for textiles," in *Functional finishes for textiles: Improving comfort, performance and protection*, R. Paul, Ed. Woodhead Publishing, 2014, pp. 429–461.
- [10] S. D. Shaw *et al.*, "Halogenated flame retardants: do the fire safety benefits justify the risks?," *Rev. Environ. Health*, vol. 25, no. 4, p. 261, 2010.
- [11] I. Van der Veen and J. de Boer, "Phosphorus flame retardants: Properties, production, environmental occurrence, toxicity and analysis," *Chemosphere*, vol. 88, no. 10, pp. 1119–1153, 2012.
- [12] G. Malucelli, "Biomacromolecules and bio-sourced products for the design of flame retarded fabrics: Current state of the art and future perspectives," *Molecules*, vol. 24, no. 20, p. 3774, 2019.

- [13] D. A. Villamil Watson and D. A. Schiraldi, "Biomolecules as flame retardant additives for polymers: A review," *Polymers (Basel)*, vol. 12, no. 4, p. 849, 2020.
- [14] G. Malucelli *et al.*, "Biomacromolecules as novel green flame retardant systems for textiles: an overview," *RSC Adv.*, vol. 4, no. 86, pp. 46024–46039, 2014.
- [15] P. C. Pereira, "Milk nutritional composition and its role in human health," *Nutrition*, vol. 30, no. 6, pp. 619–627, 2014.
- [16] W. N. Eigel *et al.*, "Nomenclature of proteins of cow's milk: Fifth revision," *J. Dairy Sci.*, vol. 67, no. 8, pp. 1599–1631, 1984.
- [17] S. Gaan and G. Sun, "Effect of phosphorus flame retardants on thermo-oxidative decomposition of cotton," *Polym. Degrad. Stab.*, vol. 92, no. 6, pp. 968–974, 2007.
- [18] S. Gaan and G. Sun, "Effect of nitrogen additives on thermal decomposition of cotton," *J. Anal. Appl. Pyrolysis*, vol. 84, no. 1, pp. 108–115, 2009.
- [19] G. G. Tesoro, S. B. Sello, and J. J. Willard, "Nitrogen-phosphorus synergism in flame-retardant cellulose," *Text. Res. J.*, vol. 39, no. 2, pp. 180–190, 1969.
- [20] M. Lewin, "Synergism and catalysis in flame retardancy of polymers," *Polym. Adv. Technol.*, vol. 12, no. 3-4, pp. 215–222, 2001.
- [21] S. Y. Lu and I. Hamerton, "Recent developments in the chemistry of halogen-free flame retardant polymers," *Prog. Polym. Sci.*, vol. 27, no. 8, pp. 1661–1712, 2002.
- [22] J. Du, H. Li, S. Xu, Q. Zhou, M. Jin, and J. Tang, "A review of organophosphorus flame retardants (OPFRs): occurrence, bioaccumulation, toxicity, and organism exposure," *Environ. Sci. Pollut. Res.*, vol. 26, no. 22, pp. 22126–22136, 2019.
- [23] A. R. Horrocks, "Flame-retardant finishes and finishing," in *Textile Finishing*, D. Heywood, Ed. Society of Dyers and Colourists, 2003, pp. 214–250.
- [24] O. Segev, A. Kushmaro, and A. Brenner, "Environmental impact of flame retardants (persistence and biodegradability)," *Int. J. Environ. Res. Public Health*, vol. 6, no. 2, pp. 478–491, 2009.
- [25] S. V. Vassilev, D. Baxter, L. K. Andersen, and C. G. Vassileva, "An overview of the chemical composition of biomass," *Fuel*, vol. 89, no. 5, pp. 913–933, 2010.
- [26] H. F. Zoller, "Casein viscosity studies," *J. Gen. Physiol.*, vol. 3, no. 5, pp. 635–651, 1921.
- [27] E. K. Choe, M. Lee, K. S. Park, and C. Chung, "Characterization of cotton fabric scouring by fourier transform-infrared attenuated total reflectance spectroscopy, gas chromatography-mass spectrometry and water absorption measurements," *Text. Res. J.*, vol. 89, no. 12, pp. 2305–2315, 2019.
- [28] A. Barth, "Infrared spectroscopy of proteins," *Biochim. Biophys. Acta (BBA)-Bioenergetics*, vol. 1767, no. 9, pp. 1073–1101, 2007.
- [29] M. B. Coltelli *et al.*, "State of the art in the development and properties of protein-based films and coatings and their applicability to cellulose based products: An extensive review," *Coatings*, vol. 6, no. 1, p. 1, 2016.
- [30] D. Price, A. R. Horrocks, M. Akalin, and A. A. Farooq, "Influence of flame retardants on the mechanism of pyrolysis of cotton (cellulose) fabrics in air," *J. Anal. Appl. Pyrolysis*, vol. 40–41, pp. 511–524, 1997.
- [31] A. M. Mocanu, C. Moldoveanu, L. Odochian, C. M. Paius, N. Apostolescu, and R. Neculau, "Study on the thermal behavior of casein under nitrogen and air atmosphere by means of the TG-FTIR technique," *Thermochim. Acta*, vol. 546, pp. 120–126, 2012.
- [32] J. Alongi *et al.*, "Caseins and hydrophobins as novel green flame retardants for cotton fabrics," *Polym. Degrad. Stab.*, vol. 99, no. 1, pp. 111–117, 2014.
- [33] E. D. Weil, N. G. Patel, M. M. Said, M. M. Hirschler, and S. Shakir, "Oxygen index: correlations to other fire tests," *Fire Mater.*, vol. 16, no. 4, pp. 159–167, 1992.
- [34] A. R. Horrocks, M. Tune, and L. Cegiela, "The burning behaviour of textiles and its assessment by oxygen-index methods," *Text. Prog.*, vol. 18, no. 1–3, pp. 1–186, 1988.
- [35] J. J. Willard and R. E. Wondra, "Quantitative evaluation of flame-retardant cotton finishes by the limiting-oxygen index (LOI) technique," *Text. Res. J.*, vol. 40, no. 3, pp. 203–210, 1970.
- [36] J. Alongi, F. Cuttica, A. Di Blasio, F. Carosio, and G. Malucelli, "Intumescent features of nucleic acids and proteins," *Thermochim. Acta*, vol. 591, pp. 31–39, 2014.
- [37] Z. Zheng, H. Wang, N. Zhang, and X. Zhao, "Heat transfer through glassfiber fabrics coated with silicone resin," *J. Text. Inst.*, vol. 108, no. 5, pp. 743–749, 2017.
- [38] S. Mandal, S. Annaheim, M. Camenzind, and R. M. Rossi, "Characterization and modelling of thermal protective performance of fabrics under different levels of radiant-heat exposures," *J. Ind. Text.*, vol. 48, no. 7, pp. 1184–1205, 2019.
- [39] M. Zhang, R. Denning, Z. Zhong, X. Wang, Y. Shen, and M. Naebe, "Investigation of heat transfer properties of plasma-treated and silicone-elastomer coated basalt fabric," *Coatings*, vol. 9, no. 5, p. 292, 2019.
- [40] A. M. Stoll and L. C. Greene, "Relationship between pain and tissue damage due to thermal radiation," *J. Appl. Physiol.*, vol. 14, no. 3, pp. 373–382, 1959.

- [41] A. M. Stoll and M. A. Chianta, "A method and rating system for evaluation of thermal protection," Naval Air Development Center Warminster Pa Aerospace Medical Research Dept, 1968.
- [42] R. M. Perkins, "Insulative values of single-layer fabrics for thermal protective clothing," *Text. Res. J.*, vol. 49, no. 4, pp. 202–212, 1979.
- [43] R. M. Rossi and T. Zimmerli, "Influence of humidity on the radiant, convective and contact heat transmission through protective clothing materials," in *Performance of Protective Clothing: Fifth Volume*, J. S. Johnson and S. Z. Mansdorf, Eds. ASTM special technical publication, 1996, pp. 269–280.
- [44] G. Sun, H. S. Yoo, X. S. Zhang, and N. Pan, "Radiant protective and transport properties of fabrics used by wildland firefighters," *Text. Res. J.*, vol. 70, no. 7, pp. 567–573, 2000.
- [45] R. M. Rossi, W. Bolli, and R. Stämpfli, "Performance of firefighters' protective clothing after heat exposure," *Int. J. Occup. Saf. Ergon.*, vol. 14, no. 1, pp. 55–60, 2008.
- [46] G. Song, S. Paskaluk, R. Sati, E. M. Crown, J. Doug Dale, and M. Ackerman, "Thermal protective performance of protective clothing used for low radiant heat protection," *Text. Res. J.*, vol. 81, no. 3, pp. 311–323, 2011.
- [47] S. Mandal, G. Song, M. Ackerman, S. Paskaluk, and F. Gholamreza, "Characterization of textile fabrics under various thermal exposures," *Text. Res. J.*, vol. 83, no. 10, pp. 1005–1019, 2013.
- [48] S. Gunesoglu and B. Meric, "Heat and mass transfer properties of 2-yarn fleece knitted fabrics," *Indian J. Fibre Text. Res.*, vol. 31, no. 3, pp. 415–421, 2006.
- [49] J. M. Souza, S. Sampaio, W. C. Silva, S. G. de Lima, A. Zille, and R. Fangueiro, "Characterization of functional single jersey knitted fabrics using non-conventional yarns for sportswear," *Text. Res. J.*, vol. 88, no. 3, pp. 275–292, 2018.
- [50] K. M. Tang, C. Kan, J. Fan, and S. Tso, "Effect of softener and wetting agent on improving the flammability, comfort, and mechanical properties of flame-retardant finished cotton fabric," *Cellulose*, vol. 24, no. 6, pp. 2619–2634, 2017.
- [51] K. M. Tang, C. Kan, J. Fan, M. K. Sarkar, and S. Tso, "Flammability, comfort and mechanical properties of a novel fabric structure: plant-structured fabric," *Cellulose*, vol. 24, no. 9, pp. 4017–4031, 2017.
- [52] K. V. Rastogi and P. Samyn, "Bio-based coatings for paper applications," *Coatings*, vol. 5, no. 4, 2015.
- [53] K. Khwaldia, "Water vapor barrier and mechanical properties of paper-sodium caseinate and paper-sodium caseinate-paraffin wax films," *J. Food Biochem.*, vol. 34, no. 5, pp. 998–1013, 2010.
- [54] K. Khwaldia, A. H. Basta, H. Aloui, and H. El-Saied, "Chitosan-caseinate bilayer coatings for paper packaging materials," *Carbohydr. Polym.*, vol. 99, pp. 508–516, 2014.
- [55] G. Rosace, E. Guido, C. Colleoni, and G. Barigozzi, "Influence of textile structure and silica based finishing on thermal insulation properties of cotton fabrics," *Int. J. Polym. Sci.*, vol. 2016, 2016.
- [56] Y. Yao, H. Wang, R. Wang, and Y. Chai, "Preparation and characterization of homogeneous and enhanced casein protein-based composite films via incorporating cellulose microgel," *Sci. Rep.*, vol. 9, no. 1, pp. 1–11, 2019.
- [57] J. L. Audic, B. Chaufer, and G. Daufin, "Non-food applications of milk components and dairy co-products: A review," *Lait*, vol. 83, no. 6, pp. 417–438, 2003.
- [58] M. Guo and G. Wang, "Milk protein polymer and its application in environmentally safe adhesives," *Polymers (Basel)*, vol. 8, no. 9, p. 324, 2016.
- [59] D. N. E. Cooper, "24—The stiffness of woven textiles," *J. Text. Inst. Trans.*, vol. 51, no. 8, pp. T317–T335, 1960.
- [60] V. Masteikaite and V. Saceviciene, "Study on tensile properties of coated fabrics and laminates," *Indian J. Fibre Text. Res.*, vol. 30, no. 3, pp. 267–272, 2005.
- [61] Y. Bulut and V. Sülar, "Effects of process parameters on mechanical properties of coated fabrics," *Int. J. Cloth. Sci. Technol.*, 2011.
- [62] N. J. Abbott, T. E. Lannefeld, L. Barish, and R. J. Brysson, "A Study of tearing in coated cotton fabrics: Part I: the influence of fabric construction," *J. Coat. Fibrous Mater.*, vol. 1, no. 1, pp. 4–17, 1971.
- [63] N. J. Abbott, T. E. Lannefeld, L. Barish, and R. J. Brysson, "A study of tearing in coated cotton fabrics: Part II: the influence of coating characteristics," *J. Coat. Fibrous Mater.*, vol. 1, no. 2, pp. 64–84, 1971.
- [64] N. J. Abbott, T. E. Lannefeld, L. Barish, and R. J. Brysson, "A study of tearing in coated cotton fabrics: Part III: the influence of coating application techniques," *J. Coat. Fibrous Mater.*, vol. 1, no. 3, pp. 130–149, 1972.
- [65] K. Rahmelow, W. Hübner, and T. Ackermann, "Infrared absorbances of protein side chains," *Anal. Biochem.*, vol. 257, no. 1, pp. 1–11, 1998.
- [66] A. Barth, "The infrared absorption of amino acid side chains," *Prog. Biophys. Mol. Biol.*, vol. 74, no. 3–5, pp. 141–173, 2000.
- [67] B. Mohanty, D. M. Mulvihill, and P. F. Fox, "Hydration-related properties of caseins at pH 2.0-3.0,"

- Food Chem.*, vol. 27, no. 3, pp. 225–236, 1988.
- [68] W. Wu, X. Zhen, and C. Q. Yang, "Correlation between limiting oxygen index and phosphorus content of the cotton fabric treated with a hydroxy-functional organophosphorus flame retarding finish and melamine-formaldehyde," *J. fire Sci.*, vol. 22, no. 1, pp. 11–23, 2004.
- [69] N. V. Bhagavan, "Amino acids," in *Medical Biochemistry*, N. V. Bhagavan, Ed. Academic Press, 2002, pp. 17–51.
- [70] S. Akabori, H. Tani, and J. Noguchi, "A synthetic amphoteric polypeptide," *Nature*, vol. 167, no. 4239, pp. 159–160, 1951.
- [71] F. Vella, "Introduction to protein structure. By C Branden and J Tooze. pp 302. garland publishing, New York. 1991 ISBN 0–8513–0270–3 (pbk)," *Biochem. Educ.*, vol. 20, no. 2, pp. 121–122, 1992.
- [72] D. G. Cornwell, "Chemistry of the amino acids, 3 volumes (Greenstein, Jesse P.; Winitz, Milton)," *J. Chem. Educ.*, vol. 39, no. 4, p. A217, 1962.
- [73] E. Q. Adms, "Relations between the constants of dibasic acids and of amphoteric electrolytes," *J. Am. Chem. Soc.*, vol. 38, no. 8, pp. 1503–1510, 1916.
- [74] N. Bjerrum, "Die konstitution der ampholyte, besonders der aminosäuren, und ihre dissoziationskonstanten," *Zeitschrift für Phys. Chemie*, vol. 104, pp. 147–173, 1923.
- [75] M. Bugajny, S. Bourbigot, M. Le Bras, and R. Delobel, "The origin and nature of flame retardance in ethylene-vinyl acetate copolymers containing hostaflam AP 750," *Polym. Int.*, vol. 48, no. 4, pp. 264–270, 1999.
- [76] F. Carosio, J. Alongi, and G. Malucelli, "Layer by layer ammonium polyphosphate-based coatings for flame retardancy of polyester-cotton blends," *Carbohydr. Polym.*, vol. 88, no. 4, pp. 1460–1469, 2012.
- [77] F. Fang *et al.*, "Intumescent flame retardant coatings on cotton fabric of chitosan and ammonium polyphosphate via layer-by-layer assembly," *Surf. Coatings Technol.*, vol. 262, pp. 9–14, 2015.
- [78] G. Camino, N. Grassie, and I. C. McNeill, "Influence of the fire retardant, ammonium polyphosphate, on the thermal degradation of poly (methyl methacrylate)," *J. Polym. Sci. Polym. Chem. Ed.*, vol. 16, no. 1, pp. 95–106, 1978.
- [79] G. Camino, L. Costa, and L. Trossarelli, "Study of the mechanism of intumescence in fire retardant polymers: Part II-Mechanism of action in polypropylene-ammonium polyphosphate-pentaerythritol mixtures," *Polym. Degrad. Stab.*, vol. 7, no. 1, pp. 25–31, 1984.
- [80] G. Camino, L. Costa, and L. Trossarelli, "Study of the mechanism of intumescence in fire retardant polymers: Part V-Mechanism of formation of gaseous products in the thermal degradation of ammonium polyphosphate," *Polym. Degrad. Stab.*, vol. 12, no. 3, pp. 203–211, 1985.
- [81] C. E. Anderson JR, D. E. Ketchum, and W. P. Mountain, "Thermal conductivity of intumescent chars," *J. Fire Sci.*, vol. 6, no. 6, pp. 390–410, 1988.
- [82] J. Alongi, Z. Han, and S. Bourbigot, "Intumescence: tradition versus novelty. A comprehensive review," *Prog. Polym. Sci.*, vol. 51, pp. 28–73, 2015.
- [83] J. Ordonez-Miranda and J. J. Alvarado-Gil, "Effect of the pore shape on the thermal conductivity of porous media," *J. Mater. Sci.*, vol. 47, no. 18, pp. 6733–6740, 2012.
- [84] J. E. J. Staggs, "Thermal conductivity estimates of intumescent chars by direct numerical simulation," *Fire Saf. J.*, vol. 45, no. 4, pp. 228–237, 2010.
- [85] J. E. J. Staggs, "Numerical characterization of the thermal performance of static porous insulation layers on steel substrates in furnace tests," *J. fire Sci.*, vol. 29, no. 2, pp. 177–192, 2011.
- [86] A. R. Horrocks, "Textile flammability research since 1980–Personal challenges and partial solutions," *Polym. Degrad. Stab.*, vol. 98, no. 12, pp. 2813–2824, 2013.
- [87] H. L. Vandersall, "Intumescent coating system, their development and chemistry," *J Fire Flamm*, vol. 2, pp. 97–140, 1971.
- [88] S. Bourbigot, M. Le Bras, S. Duquesne, and M. Rochery, "Recent advances for intumescent polymers," *Macromol. Mater. Eng.*, vol. 289, no. 6, pp. 499–511, 2004.
- [89] H. S. Mansur, C. M. Sadahira, A. N. Souza, and A. A. P. Mansur, "FTIR spectroscopy characterization of poly (vinyl alcohol) hydrogel with different hydrolysis degree and chemically crosslinked with glutaraldehyde," *Mater. Sci. Eng. C*, vol. 28, no. 4, pp. 539–548, 2008.
- [90] J. Xie and Y. L. Hsieh, "Ultra-high surface fibrous membranes from electrospinning of natural proteins: casein and lipase enzyme," *J. Mater. Sci.*, vol. 38, no. 10, pp. 2125–2133, 2003.
- [91] J. W. Gilman, D. L. VanderHart, and T. Kashiwagi, "Thermal decomposition chemistry of poly(vinyl alcohol) char characterization and reactions with bismaleimides," ACS Publications, 1995.
- [92] H. Yang, S. Xu, L. Jiang, and Y. Dan, "Thermal decomposition behavior of poly (vinyl alcohol) with different hydroxyl content," *J. Macromol. Sci. Part B*, vol. 51, no. 3, pp. 464–480, 2012.
- [93] H. Peng, S. Wang, H. Xu, and X. Hao, "Preparation, properties and formation mechanism of cellulose/polyvinyl alcohol bio-composite hydrogel membranes," *New J. Chem.*, vol. 41, no. 14, pp. 6564–6573, 2017.
- [94] G. E. Zaikov and S. M. Lomakin, "Innovative type of low flammability varnish based on poly(vinyl alcohol)," *Polym. Degrad. Stab.*, vol. 57, no. 3, pp. 279–282, 1997.

- [95] J. Alongi, J. Milnes, G. Malucelli, S. Bourbigot, and B. Kandola, "Thermal degradation of DNA-treated cotton fabrics under different heating conditions," *J. Anal. Appl. Pyrolysis*, vol. 108, pp. 212–221, 2014.
- [96] W. Wu and C. Q. Yang, "Correlation between limiting oxygen index and phosphorus/nitrogen content of cotton fabrics treated with a hydroxy-functional organophosphorus flame-retarding agent and dimethyloldihydroxyethyleneurea," *J. Appl. Polym. Sci.*, vol. 90, no. 7, pp. 1885–1890, 2003.
- [97] G. E. Zaikov and S. M. Lomakin, "New aspects of ecologically friendly polymer flame retardant systems," *Polym. Degrad. Stab.*, vol. 54, no. 2–3, pp. 223–233, 1996.
- [98] Y. M. Lee and R. L. Barker, "Thermal protective performance of heat-resistant fabrics in various high intensity heat exposures," *Text. Res. J.*, vol. 57, no. 3, pp. 123–132, 1987.
- [99] F. Shams-Ghahfarokhi, A. Khoddami, Z. Mazrouei-Sebdani, J. Rahmatinejad, and H. Mohammadi, "A new technique to prepare a hydrophobic and thermal insulating polyester woven fabric using electro-spraying of nano-porous silica powder," *Surf. Coatings Technol.*, vol. 366, pp. 97–105, 2019.
- [100] Y. K. Kang, C. H. Park, J. Kim, and T. J. Kang, "Application of electrospun polyurethane web to breathable water-proof fabrics," *Fibers Polym.*, vol. 8, no. 5, pp. 564–570, 2007.
- [101] H. Wang, W. Li, and Z. Li, "A facile strategy for preparing pcl/peg block copolymer microspheres via electro-spraying as coatings for cotton fabrics," *Macromol. Mater. Eng.*, vol. 303, no. 8, p. 1800164, 2018.
- [102] Y. Shin, D. Yoo, and K. Son, "Development of thermoregulating textile materials with microencapsulated phase change materials (PCM). IV. Performance properties and hand of fabrics treated with PCM microcapsules," *J. Appl. Polym. Sci.*, vol. 97, no. 3, pp. 910–915, 2005.
- [103] M. S. Tözüm and S. A. Aksoy, "Investigation of tactile comfort properties of the fabrics treated with microcapsules containing phase change materials (PCMs microcapsules)," *J. Text. Inst.*, vol. 107, no. 9, pp. 1203–1212, 2016.
- [104] G. T. V Prabu *et al.*, "Moisture management finish on cotton fabric by electro-spraying," *Text. Res. J.*, vol. 87, no. 17, pp. 2154–2165, 2017.
- [105] V. Dal, R. Şimşek, L. Hes, E. Akçagün, and A. Yılmaz, "Investigation of thermal comfort properties of zinc oxide coated woven cotton fabric," *J. Text. Inst.*, vol. 108, no. 3, pp. 337–340, 2017.
- [106] J. L. Castillo, S. Martin, D. Rodriguez-Perez, F. J. Higuera, and P. L. Garcia-Ybarra, "Nanostructured porous coatings via electro-spray atomization and deposition of nanoparticle suspensions," *J. Aerosol Sci.*, vol. 125, pp. 148–163, 2018.
- [107] Z. Zhifeng and Q. Kun, "Effects of the molecular structure of polyvinyl alcohol on the adhesion to fibre substrates," *Fibres Text. East. Eur.*, vol. 15, no. 1, p. 82, 2007.
- [108] J. Kim and G. Cho, "Thermal storage/release, durability, and temperature sensing properties of thermostatic fabrics treated with octadecane-containing microcapsules," *Text. Res. J.*, vol. 72, no. 12, pp. 1093–1098, 2002.
- [109] S. Anita, T. Ramachandran, R. Rajendran, C. V Koushik, and M. Mahalakshmi, "A study of the antimicrobial property of encapsulated copper oxide nanoparticles on cotton fabric," *Text. Res. J.*, vol. 81, no. 10, pp. 1081–1088, 2011.
- [110] F. Giacomini, A. A. U. de Souza, and M. A. S. D. de Barros, "Comparative study of dyeing with cochineal dye in cationized cotton with various proteins," *J. Nat. Fibers*, pp. 1–13, 2020.
- [111] G. Yang, L. Zhang, H. Han, and J. Zhou, "Cellulose/casein blend membranes from NaOH/urea solution," *J. Appl. Polym. Sci.*, vol. 81, no. 13, pp. 3260–3267, 2001.
- [112] S. E. Kiehna, Z. R. Laughrey, and M. L. Waters, "Evaluation of a carbohydrate- π interaction in a peptide model system," *Chem. Commun.*, no. 39, pp. 4026–4028, 2007.
- [113] J. Gu and J. M. Catchmark, "Polylactic acid composites incorporating casein functionalized cellulose nanowhiskers," *J. Biol. Eng.*, vol. 7, no. 1, pp. 1–10, 2013.
- [114] J. G. Frick Jr and R. J. Harper Jr, "Crosslinking cotton cellulose with aldehydes," *J. Appl. Polym. Sci.*, vol. 27, no. 3, pp. 983–988, 1982.
- [115] H. Choi, J. H. Kim, and S. Shin, "Characterization of cotton fabrics treated with glyoxal and glutaraldehyde," *J. Appl. Polym. Sci.*, vol. 73, no. 13, pp. 2691–2699, 1999.
- [116] A. Ghosh, M. A. Ali, and G. J. Dias, "Effect of cross-linking on microstructure and physical performance of casein protein," *Biomacromolecules*, vol. 10, no. 7, pp. 1681–1688, 2009.
- [117] S. Farris, J. Song, and Q. Huang, "Alternative reaction mechanism for the cross-linking of gelatin with glutaraldehyde," *J. Agric. Food Chem.*, vol. 58, no. 2, pp. 998–1003, 2010.
- [118] B. A. Kottes, "Nonformaldehyde DP finishing of cotton with citric acid," *Text. Chem. Color.*, vol. 22, no. 9, pp. 63–67, 1990.
- [119] C. Q. Yang, X. Wang, and I. S. Kang, "Ester crosslinking of cotton fabric by polymeric carboxylic acids and citric acid," *Text. Res. J.*, vol. 67, no. 5, pp. 334–342, 1997.
- [120] N. Bhattacharya and A. S. Sahasrabudhe, "Cost effective catalyst for polycarboxylic acid finishing," *Text. Chem. Color.*, vol. 31, no. 6, pp. 33–37, 1999.
- [121] C. Q. Yang, Z. Mao, and G. C. Lickfield, "Ester crosslinking of cotton cellulose by polycarboxylic acids: pH-dependency," *Text. Chem. Color. Am. Dyest. Report.*, vol. 32, no. 11, pp. 43–46, 2000.

- [122] N. Reddy, Y. Li, and Y. Yang, "Alkali-catalyzed low temperature wet crosslinking of plant proteins using carboxylic acids," *Biotechnol. Prog.*, vol. 25, no. 1, pp. 139–146, 2009.
- [123] T. Li *et al.*, "Surface hydrophobicity and functional properties of citric acid cross-linked whey protein isolate: The impact of pH and concentration of citric acid," *Molecules*, vol. 23, no. 9, p. 2383, 2018.
- [124] A. E. Hagerman, "Chemistry of tannin-protein complexation," in *Chemistry and Significance of Condensed Tannins*, R. W. Hemingway, J. J. Karchesy, and S. J. Branham, Eds. Springer Nature, 1989, pp. 323–333.
- [125] H. R. Tang, A. D. Covington, and R. A. Hancock, "Structure–activity relationships in the hydrophobic interactions of polyphenols with cellulose and collagen," *Biopolym. Orig. Res. Biomol.*, vol. 70, no. 3, pp. 403–413, 2003.
- [126] E. R. Deaville, R. J. Green, I. Mueller-Harvey, I. Willoughby, and R. A. Frazier, "Hydrolyzable tannin structures influence relative globular and random coil protein binding strengths," *J. Agric. Food Chem.*, vol. 55, no. 11, pp. 4554–4561, 2007.
- [127] C. Le Bourvellec and C. Renard, "Interactions between polyphenols and macromolecules: quantification methods and mechanisms," *Crit. Rev. Food Sci. Nutr.*, vol. 52, no. 3, pp. 213–248, 2012.
- [128] N. Bordenave, B. R. Hamaker, and M. G. Ferruzzi, "Nature and consequences of non-covalent interactions between flavonoids and macronutrients in foods," *Food Funct.*, vol. 5, no. 1, pp. 18–34, 2014.
- [129] P. Pisitsak, J. Hutakamol, R. Thongcharoen, P. Phokaew, K. Kanjanawan, and N. Saksaeng, "Improving the dyeability of cotton with tannin-rich natural dye through pretreatment with whey protein isolate," *Ind. Crops Prod.*, vol. 79, pp. 47–56, 2016.
- [130] J. Luo *et al.*, "A highly stretchable, real-time self-healable hydrogel adhesive matrix for tissue patches and flexible electronics," *Adv. Healthc. Mater.*, vol. 9, no. 4, p. 1901423, 2020.
- [131] A. A. Watrelot and E. L. Norton, "Chemistry and reactivity of tannins in vitis spp.: A review," *Molecules*, vol. 25, no. 9, p. 2110, 2020.
- [132] C. Tomasino, "Durable press finishes," in *Chemistry & technology of fabric preparation & finishing*, Department of Textile Engineering, Chemistry & Science College of Textiles North Carolina State University Raleigh, North Carolina, 1992, pp. 97–133.
- [133] W. D. Schindler and P. J. Hauser, "Easy-care and durable press finishes of cellulose," in *Chemical finishing of textiles*, W. D. Schindler and P. J. Hauser, Eds. Woodhead Publishing, 2004, pp. 51–73.
- [134] S. L. Vail and W. C. Arney JR, "Reaction mechanisms of glyoxal-based durable-press resins with cotton," *Text. Res. J.*, vol. 41, no. 4, pp. 336–344, 1971.
- [135] P. Bajaj, "Finishing of textile materials," *J. Appl. Polym. Sci.*, vol. 83, no. 3, pp. 631–659, 2002.
- [136] V. A. Dehabadi, H. J. Buschmann, and J. S. Gutmann, "Durable press finishing of cotton fabrics: An overview," *Text. Res. J.*, vol. 83, no. 18, pp. 1974–1995, 2013.
- [137] A. Kongdee, T. Bechtold, and L. Teufel, "Modification of cellulose fiber with silk sericin," *J. Appl. Polym. Sci.*, vol. 96, no. 4, pp. 1421–1428, 2005.
- [138] A. Kongdee and N. Chinthawan, "Modification of cotton fibers with sericin using non-formaldehyde released crosslinking agents," *Res. J. Text. Appar.*, vol. 11, no. 3, p. 18, 2007.
- [139] C. J. Brinker and G. W. Scherer, *Sol-gel science: the physics and chemistry of sol-gel processing*. Academic press, 2013.
- [140] M. Abdelmouleh, S. Boufi, A. ben Salah, M. N. Belgacem, and A. Gandini, "Interaction of silane coupling agents with cellulose," *Langmuir*, vol. 18, no. 8, pp. 3203–3208, 2002.
- [141] Y. Xie, C. A. S. Hill, Z. Xiao, H. Miltz, and C. Mai, "Silane coupling agents used for natural fiber/polymer composites: A review," *Compos. Part A Appl. Sci. Manuf.*, vol. 41, no. 7, pp. 806–819, 2010.
- [142] M. K. Thakur, R. K. Gupta, and V. K. Thakur, "Surface modification of cellulose using silane coupling agent," *Carbohydr. Polym.*, vol. 111, pp. 849–855, 2014.
- [143] E. Alonso, L. A. Pothan, A. Ferreira, and N. Cordeiro, "Surface modification of banana fibers using organosilanes: An IGC insight," *Cellulose*, vol. 26, no. 6, pp. 3643–3654, 2019.
- [144] J. F. Lambert, "Adsorption and polymerization of amino acids on mineral surfaces: a review," *Orig. Life Evol. Biosph.*, vol. 38, no. 3, pp. 211–242, 2008.
- [145] N. Kitadai, T. Yokoyama, and S. Nakashima, "ATR-IR spectroscopic study of L-lysine adsorption on amorphous silica," *J. Colloid Interface Sci.*, vol. 329, no. 1, pp. 31–37, 2009.
- [146] A. Rimola, D. Costa, M. Sodupe, J.-F. Lambert, and P. Ugliengo, "Silica surface features and their role in the adsorption of biomolecules: computational modeling and experiments," *Chem. Rev.*, vol. 113, no. 6, pp. 4216–4313, 2013.
- [147] L. Conzatti *et al.*, "Wool fibres functionalised with a silane-based coupling agent for reinforced polypropylene composites," *Compos. Part A Appl. Sci. Manuf.*, vol. 61, pp. 51–59, 2014.
- [148] F. Pawlak, M. Aldas, F. Parres, J. López-Martínez, and M. P. Arrieta, "Silane-functionalized sheep wool fibers from dairy industry waste for the development of plasticized PLA composites with maleinized linseed oil for injection-molded parts," *Polymers (Basel)*, vol. 12, no. 11, p. 2523, 2020.

- [149] Z. Zainudin, N. I. S. Mohd Yusoff, M. U. Wahit, and S. H. C. Man, "Mechanical, thermal, void fraction and water absorption of silane surface modified silk fiber reinforced epoxy composites," *Polym. Technol. Mater.*, vol. 59, no. 18, pp. 1987–2002, 2020.
- [150] L. Peng *et al.*, "Silver nanoparticles coating on silk fabric with pretreatment of 3-aminopropyltrimethoxysilane in supercritical carbon dioxide," *J. Ind. Text.*, vol. 47, no. 5, pp. 883–896, 2018.

8 List of publications by the author

Journal publications

- **Faheem S.**, Nahid N., Wiener J., Baheti V., Mazari, A., Militky J., "Estimation of radiant heat resistance of cotton fabrics treated with bio-based flame retardant," *Journal of Fiber Bioengineering and Informatics (Textile Bioengineering and Informatics Society; The Hong Kong Polytechnic University)*, vol. 15, no. 2, pp. 67-77, 2022. (Impact Score = 0.33)
- **Faheem S.**, Baheti V., Tunak M., Wiener J., Militky J., "Flame resistance behavior of cotton fabrics coated with bilayer assemblies of ammonium polyphosphate and casein," *Cellulose (Springer)*, vol. 26, no. 5, pp. 3557-3574, 2019. (Impact factor = 6.123)
- **Faheem S.**, Baheti V., Nahid N., Tunak M., Wiener J., Militky J., "Flame retardancy, physiological comfort and durability of casein treated cotton fabrics," *Fibers and Polymers (Springer)*, vol. 20, no. 5, pp. 1011-1020, 2019. (Impact factor = 2.347)
- **Faheem S.**, Baheti V., Tunak M., Wiener J., Militky J., "Comparative performance of flame retardancy, physiological comfort, and durability of cotton textiles treated with alkaline and acidic casein suspension," *Journal of Industrial Textiles (Sage Publications)*, vol. 48, no. 6, pp. 969-991, 2019, First published online on Dec. 2017. (Impact factor = 2.926)
- **Faheem S.**, Baheti V., Behera P., Naeem S., "Development of flame retardant high loft polyester nonwovens," *Journal of The Textile Institute (Taylor & Francis)*, vol. 108, no. 8, pp. 1357-1364, 2017, First published online on Nov. 2016. (Impact factor = 1.770)
- **Faheem S.**, Rehman M. S. N., Nahid N., Militky J., Wiener J., "SARS-CoV-2: Brief history and molecular biology," *Journal of Fiber Bioengineering and Informatics (Textile Bioengineering and Informatics Society; The Hong Kong Polytechnic University)*, vol. 13, no. 4, pp. 181-194, 2020. (Impact score = 0.33)
- Azeem A., Abid S., Sarwar Z., Iqbal Z., Khalid F., Haseeb M. A., **Faheem S.**, Hussain T., Munir U., Saleem M. J., "Synthesis and Application of Titanium Dioxide Nanoparticles on Cotton Fabrics for UV Protection," *Journal of Textile and Apparel, Technology and Management (Department of Textile and Apparel, Technology and Management; North Carolina State University)*, vol. 11, no. 3, pp. 2020. (Impact score = 0.37)
- Ahmad H., Tariq A., Shehzad A., **Faheem S.**, Shafiq M., Rashid I. A., Afzal A., Munir A., Riaz M. T., Haider H. T., Afzal A., Qadir B., Khaliq Z., "Stealth technology: Methods and composite materials-A review," *Polymer Composites (John Wiley & Sons)*, vol. 40, no. 12, pp. 4457-4472, 2019. (Impact factor = 3.531)
- Hai A. M., Ahmed M., Afzal A., Jabbar A., **Faheem S.**, "Characterization and antibacterial property of Kapok fibers treated with chitosan/AgCl-TiO₂ colloid," *Journal of The Textile Institute (Taylor & Francis)*, vol. 110, no. 1, pp. 100-104, 2019. (Impact factor = 1.770)
- Nazir A., Hussain T., Afzal A., **Faheem S.**, Ibrahim W., Bilal M., "Prediction and correlation of air permeability and light transmission properties of woven cotton fabrics," *Autex Research Journal (Sciendo)*, vol. 17, no. 1, pp.61-66, 2016. (Impact factor = 1.944)
- **Faheem S.**, Nahid N., Wiener J., Mazari, A., Baheti V., Militky J., "Flame retardant and intumescent char formation potentials of cotton fabrics fabricated by deposition of casein based bicomponent composite nanoparticles," Under submission process for publication.
- **Faheem S.**, Nahid N., Wiener J., Mazari, A., Baheti V., Militky J., "Effect of different chemical crosslinking systems on durability enhancement of casein finished flame retardant cotton fabrics," Under submission process for publication.
- **Faheem S.**, Nahid N., Wiener J., Mazari, A., Baheti V., Militky J., "Construction of casein based intumescent flame retardant coatings on cotton fabrics through layer by layer assembly technique," Under manuscript compilation for submission.

Conference publications

- **Faheem S.**, Wiener J., Mazari A., Nahid N., Militky J., "Needless electrohydrodynamic deposition of biopolymer based bicomponent composite coatings on textile fabrics," *The Fiber Society's 2022 Fall Conference*, Raleigh, North Carolina, USA, October 2022.
- **Faheem S.**, Nahid N., Wiener J., Mazari A., Baheti V., Militky J., "Textile flame retardancy and valorization of biobased materials as green flame retardants," *The 15th Textile Bioengineering and Informatics Symposium - TBIS 2022 Webinar*, Liberec, Czech Republic, September 2022.
- **Faheem S.**, Nahid N., Wiener J., Mazari A., Baheti V., Militky J., "Comparative evaluation of thermal degradation, burning behavior, and intumescent char formation of cotton fabrics coated with alkaline and acidic casein solutions," *21st World Textile Conference - AUTEX 2022 Online*, Lodz, Poland, June 2022.
- **Faheem S.**, Nahid N., Wiener J., Baheti V., Mazari A., Militky J., "Evaluation of radiant heat transmission of biopolymer based flame retardant treated cotton fabrics," *The 14th Textile Bioengineering and Informatics Symposium - TBIS 2021 Webinar*, Roubaix, France, July 2021.
- **Faheem S.**, Militky J., Wiener J., "Characterization, indication and passivation of SARS-CoV-2," *The 13th Textile Bioengineering and Informatics Symposium - TBIS 2020 Webinar*, Shanghai, China, July 2020.
- **Faheem S.**, Baheti V., Tunak M., Wiener J., Militky J., "An evaluation study of thermal stability, physiological comfort and mechanical properties of flame resistance cotton fabrics treated with bovine milk casein," *23rd World Conference on Applied Science Engineering and Technology*, Melbourne, Australia, October 2019.
- **Faheem S.**, Baheti V., Tunak M., Wiener J., Militky J., "Evaluation of flammability and thermal stability features of cotton fabric modified with novel and ecofriendly intumescent flame resistance coatings of milk casein," *Nanofibers, Applications and Related Technologies - NART 2019*, Liberec, Czech Republic, September 2019.
- **Faheem S.**, Baheti V., Tunak M., Wiener J., Militky J., "Intumescent flame retardant bilayer coatings of casein and ammonium polyphosphate on cotton fabric," *The Fiber Society's 2018 Fall Conference*, Davis, California, USA, October 2018.
- **Faheem S.**, Baheti V., Tunak M., Wiener J., Militky J., "Casein treated flame retardant textiles," *The 45th Textile Research Symposium*, Kyoto, Japan, September 2017.

Book chapters

- **Faheem S.**, Wiener J., Militky J., Mazari A., "Fundamental aspects of textile flame retardancy," in *Selected Topics in Fibrous Materials Science*, ISBN: 978-80-7494-607-3, vol. 6, pp. 219-239, 2022.
- **Faheem S.**, Nahid N., Rehman M. S. N., Militky J., Wiener J., "Characterization, indication and passivation of COVID-19," in *Textiles and Their Use in Microbes Protection - Focus on COVID-19 and Other Viruses*, Taylor & Francis and CRC Press, ISBN: 9780367691059, pp. 113-134, 2021.
- **Faheem S.**, Baheti V., Wiener J., Militky J., "Biomacromolecule; Bovine milk casein as novel green flame retardant system for cotton fabric," in *Recent Developments in Fibrous Material Science*, ISBN: 978-80-7494-493-2, vol. 5, pp. 291-312, 2019.
- Baheti V., **Faheem S.**, Naeem S., Prusova M., Militky J., "Novel strategies for flame retardant high loft polyester nonwovens," *Recent Developments in Fibrous Material Science*, ISBN: 978-80-87269-45-9, vol. 2, pp. 384-402, 2016.
- **Faheem S.**, Nahid N., Wiener J., Militky J., Mazari A., "Flame retardancy of textiles - New strategies and mechanisms," in *Advanced Multifunctional Materials from Fibrous Structures*, Springer, Under manuscript compilation for submission.

9 Curriculum Vitae

Muhammad Sajid Faheem

Ph.D. Student

Department of Material Engineering

Faculty of Textile Engineering

Technical University of Liberec, Czech Republic

OBJECTIVE

To work innovatively, wholeheartedly, and honestly to become distinct and want to excel in the field of academia and research work.

PERSONAL INFORMATION

Name:	Muhammad Sajid Faheem
Date of Birth:	10 March 1983
Place of Birth:	Faisalabad, Pakistan
Nationality:	Pakistani
Phone:	+420773057082
Gender:	Male
Languages:	English, Urdu, Punjabi
Address (Pakistan):	Police Hospital, Mohalla Police Lines, Faisalabad
Address (Czech Republic):	Jestedska 341/103, 46008, Liberec VIII, Dolni Hanychov
E-mail:	msajidfaheem@gmail.com , muhammad.sajid.faheem@tul.cz

SCHOLASTIC RECORD

Ph.D. Textile Technics and Material Engineering (In Progress)

Technical University of Liberec, Liberec, Czech Republic

M.Sc. Textile Engineering (2010 – 2012)

National Textile University, Faisalabad, Pakistan
CGPA obtained 3.80/4.00

B.Sc. Textile Engineering (2003 – 2007)

(Specialization in Textile Chemistry)
National Textile University, Faisalabad, Pakistan
CGPA obtained 3.49/4.00

PROFESSIONAL EXPERIENCE

Lecturer (Mar 2012 – Oct 2014)

Department of Textile Technology
School of Engineering and Technology,
National Textile University, Faisalabad, Pakistan

Assistant Manager QC and CS (Oct 2009 – Mar 2012)

Sandal Dyestuff Industries (Ltd), Faisalabad, Pakistan

Assistant Manager Techno Commercial (Mar 2009 – Sep 2009)

Sandalbar Enterprises (Pvt), Ltd. Faisalabad, Pakistan

Assistant Finishing Manager (Feb 2008 – Mar 2009)

Department of Textile Finishing
Chenab Limited, Faisalabad, Pakistan

SKILLS AND COMPETENCIES

Personal

- Enthusiastic, flexible, adaptive, and quick learner
- Dedicated to work, patience, and good communication skills

Institutional

- Enjoy working with other people and team members
- Leadership, mentoring, and organization qualities
- Aware of quality improvement tools

Technical

- Awareness of research methods, designing of different types of experiments, data analysis, materials testing, and analytical tools

Digital

- Planning and production, quality improvement, cost analysis, event management, and risk analysis
- Good command of MS Office, and MS Visio
- Good command of OriginLab and Minitab statistical data analysis

AWARDS AND HONORS

- Received the best research work poster presentation award at The Fiber Society's 2022 Fall Conference, Raleigh, North Carolina, USA, October 2022
- Received the best research work oral presentation award at 23rd World Conference on Applied Science Engineering and Technology, Melbourne, Australia, October 2019
- Received the best research work oral and poster presentation award at International Ph.D. Students Day for the years 2018, 2019, 2021 during Ph.D. study at the Faculty of Textile Engineering, Technical University of Liberec, Czech Republic
- Secured the overall 2nd position in M.Sc. Textile Engineering

RESEARCH AND SCIENTIFIC ACTIVITIES

- Selected for Student Grant Competition Projects and performed well the activities as a leader for the years 2017, 2018, 2019 and as a co-investigator member for the years 2020, 2022 during Ph.D. study at Technical University of Liberec, Czech Republic
- Conducted the supervision of internee and erasmus students on various research topics
- Selected as Student Ambassador Pakistan at Technical University of Liberec, Czech Republic

PROFESSIONAL MEMBERSHIPS

- Member of Alumni Association, National Textile University, Faisalabad, Pakistan
 - Member of Pakistan Engineering Council, Pakistan
-

10 Recommendation of Supervisor

Supervisor's Opinion on Ph.D. Thesis of Mr. Muhammad Sajid Faheem, M.Sc.

The Ph.D. thesis of Mr. Muhammad Sajid Faheem, M.Sc. is titled "Biopolymer for reduction of cotton flammability". His Ph.D. study specialization is "Textile Technic and Material Engineering". He is excellent hardworking and good at research. During his Ph.D., he validated his skill to execute high quality research with full motivation and dedication.

This Ph.D. thesis is written well and comprehensively according to the required standard format. This Ph.D. thesis fulfills the outlined objectives. The main focus of this research work study is to scrutinize the applications of a biopolymer (bovine milk casein) on cotton fabrics as green and environment-friendly flame retardant finishing material.

Biopolymers are film forming materials with interesting properties generally which will be in future used in many applications. In the case of reduction of flammability it can be a way to prepare halogen and formaldehyde free composition that can replace common chemicals for cellulosic materials. Casein protein is applied on cotton fabrics just as it alone and in combination with other environment-friendly materials for synergistic effects through non-hazardous aqueous solutions and simple industrial applicable textile finishing techniques.

He performed all his work systematically with specific objectives and on a required scientific level. He organized and analyzed the data scientifically with logical discussions of results. The language and grammar level of the thesis is good and meet the Ph.D. standard. The conclusions of the thesis are interesting, valuable, and ready to be used in practice. Overall, the work shows his ability to design a realize research and evaluate and discuss experimental results including theoretical models.

His publication activities show that he is a high level researcher. During his Ph.D. research work he has a number of publications; including of 10 articles in impact factor journal, 4 book chapters and several international conference articles. Many others of his papers are now under review.

I therefore recommend the thesis of Mr. Muhammad Sajid Faheem for final defense.

Prof. Ing. Jakub Wiener, Ph.D.

(Supervisor)

Department of Material Engineering

Faculty of Textile Engineering

Technical University of Liberec, Czech Republic

Date: 17.2.2023

11 Reviews of the Opponents

Opponent's review

This opponent's review was elaborated based on doc. Ing. Vladimír Bajžík, Ph.D. (dean of Faculty of Textile, Technical University in Liberec) assignment for review Ph.D. dissertation thesis (ref. no. TUL23/4814/014204, dated 4.4.2023) of **Muhammad Sajid Faheem, M.Sc.** entitled **“Biopolymer for Reduction of Cotton Flammability”**. Tutor of the PhD. student was Prof. Ing. Jakub Wiener, Ph.D.

Theses presented represents complex experimental study focused on reduction of the cotton fabric flammability by application of natural biopolymers. Thesis presented from the formal point of view are composed of 143 pages (A4 format) text divided into 6 chapters. Thesis are written in English language in the form of the monograph. Thesis total references cited was 417. There were cited fundamental research articles as well as the latest publications.

Main objectives of the theses were the preparation of casein aqueous solutions of different concentrations for impregnation of tested fabrics for flame retardant treatment of the cotton and for characterization of the char formation properties for cotton fabrics. Furthermore there were studied flame retardant properties of different casein based coatings such as alkaline and acidic casein, combination of casein with ammonium polyphosphate and polyvinyl alcohol. Finally, the washing durability of casein treated cotton fabrics was studied as well. Wide range of physicochemical, structural analysis, thermal and mechanical properties characterization techniques were employed during the study.

Results of the thesis of the applicant Faheem were published in 13 scientific papers in scientific journals (8 of them were in impacted journals registered in WoS), 9 conference proceedings contributions and 5 book chapters. Due to the fact, that the thesis results were published in recognized scientific journals and underwent vigorous peer review process, I will not be evaluating again the scientific merit of the applicants research output. The quality of the results and their interpretation was approved already by the acceptance and publishing the results in the respected scientific international journals.

Based on the latter mentioned facts and by the course of law (Higher Education Law No. 111/1998. Sb.) §47 I recommend to accept the PhD. dissertation thesis of Muhammad Sajid Faheem, M.Sc. for defense.

In Zlín, May 2, 2023

Assoc Prof. Mgr. *Barbora* Lapčíková, Ph.D.

Associated professor for materials science and Engineering, Tomas Bata University in Zlín

Opponent's Review Report

Thesis Title: Biopolymer for Reduction of Cotton Flammability

Thesis Author: Muhammad Sajid Faheem, M.Sc.

Study Specialization: Textile Technics and Material Engineering

Thesis Supervisor: prof. Ing. Jakub Wiener, Ph.D.

Opponent Reviewer: doc. Ing. Stanislav Petřík, CSc.

The presented Ph.D. dissertation thesis comprises abstract, comprehensive 6 chapters (introduction – significance, scope and objectives, literature review, experimental part, results and discussion, conclusions and future perspectives), references, and a list of publications elucidating the different essential parts. This dissertation thesis deals with the study of applications of biopolymer material for flame retardancy, char formation, and intumescence effect for cotton fabrics, furthermore, as its impact on basic essential and desired properties of cotton fabrics. The research work is conducted by exploiting casein application on cotton fabrics just as it alone and in combination with other environmentally friendly materials for synergistic and/or hybrid effects. In particular, its application on cotton fabrics through non-hazardous solvents and/or solutions by utilizing simple, time-saving, and industrially applicable techniques/methods is also explored.

The selected theme is scientifically advanced signifying innovative trends towards the utilization of bio-based natural and renewable materials/products that have become of growing interest and gained significant importance because of their environmental friendliness. The dissertation thesis is written very well in good English and entirely understandable with minimum formatting mistakes and typing errors. The scientific content of the dissertation thesis is quite logical. The abstract summarizes the whole research work rationally. The introduction and the state-of-the-art are broadly discussed including a large literature survey representing the author's sufficient scientific background. The planned aims and objectives are understandable and well-defined. The experimental part designates the used materials and methodology in a systematic way explaining sufficient details. The solutions preparation processes, the samples development methods, and the characterization/testing techniques are appropriately selected and described with sufficient details. The attained results are discussed and concluded precisely to study and investigate the causes with specific reasons for observance of different functional properties. Overall, it can

be observed that the defined goals of the dissertation thesis are achieved together with the necessary focus on many other parameters. However, I would appreciate more structured and briefer conclusion part, with most significant achievements highlighted and prioritized.

The individual research work steps undertaken in this study are based on the current knowledge in the field and proved to be appropriate for this kind of studies. This research work confers very useful results that present a good contribution to the field of textile flame retardancy.

The author has published multiple articles related to thesis, there are 7 SI published articles and 5 book chapters which are published in well-recognized journals, author also represented his research in multiple conferences nationally and internationally.

During the defense student can answer the following questions:

- Can you please discuss consistency of bio-based flame retardant materials, especially in the context of reproducibility of parameters for potential industrial production of the processed textiles (the influence of variability of individual batches of raw materials).
- What is future of this work and how the results are comparable to products which are available in the market?

All things considered; it is concluded that this research work complies with the requirements for Ph.D. quality standards. Based on the above review, I do recommend this dissertation thesis submitted by Mr. Muhammad Sajid Faheem for final defense.

Place and Date: In Liberec on May 30, 2023

**Ing.
Stanislav
Petrík,
CSc.** Digitálně
podepsal Ing.
Stanislav Petrík,
CSc.
Datum:
2023.05.30
20:14:44 +02'00'

doc. Ing. Stanislav Petrík, CSc.